

ATARI®

ST™ Computer



Owner's Manual

IMPORTANT INFORMATION

Like any electrical appliance, the ATARI ST Computer uses and produces radio-frequency energy. If not installed and used according to the instructions in this manual, the equipment may cause interference with your radio and TV reception.

If you believe that this equipment is causing interference with your radio or TV reception, try switching the equipment off and on. If the interference problem stops when the equipment is switched off, then the equipment is probably causing the interference. You may be able to correct the problem by trying one or more of the following measures:

- Adjust the position of the radio or TV antenna.
- Reposition the equipment in relation to the radio or television.
- Move the equipment away from the radio or television.
- Plug the equipment into a different wall outlet so that the equipment and the radio or television are connected to different branch circuits.

If necessary, consult your ATARI Computer retailer or an experienced radio-television technician for additional suggestions.

A resource that you may find helpful is a booklet prepared by the Federal Communications Commission: *How to Identify and Resolve Radio-TV Interference Problems*. This booklet is available from the U.S. Government Printing Office, Washington, DC 20402, Stock No. 004-000-00345-4.

WARNING: This equipment has been certified to comply with the limits for a Class B computing device, pursuant to Subpart J of Part 15 of the FCC rules. Those rules are designed to provide reasonable protection from interference when the equipment is used in a residential setting. However, there is no guarantee that interference will not occur in a particular home or residence. Only peripherals (computer input/output devices—terminals, printers, etc.) that have been certified to comply with the Class B limits may be attached to this computer. Operation of noncertified peripherals with this computer is likely to result in interference with radio and TV reception. Shielded cables should be used on all I/O connectors (except the joystick and mouse connectors); otherwise, radio emissions may exceed Class B limits.

Every effort has been made to ensure the accuracy of the product documentation in this manual. However, because Atari Corporation is constantly improving and updating its computer hardware and software, we are unable to guarantee the accuracy of printed material after the date of publication and disclaim liability for changes, errors, or omissions.

ATARI, NEOchrome, ST, ST BASIC, ST LOGO, 520ST, 1040ST, and TOS are trademarks or registered trademarks of Atari Corporation. GEM is a registered trademark of Digital Research Inc. VT is a registered trademark of Digital Equipment Corporation.



Copyright ©1987, Atari Corporation
Sunnyvale, CA 94089
All rights reserved.



ATARI®

ST™ Computer

Owner's Manual







TABLE OF CONTENTS

INTRODUCTION	1
How to Use This Manual	1
CHAPTER 1: GETTING STARTED	5
Unpacking Instructions	5
Connecting the System	5
The Computer and Disk Drive	6
The Mouse	7
The Video Display	7
A Second Disk Drive	9
Connecting a 3-Pin Plug to the Mains Lead	10
Ports	11
The Back Panel	11
The Left Side Panel	13
The Right Side Panel	14
The Right Underside	14
CHAPTER 2: OPERATING YOUR ST COMPUTER:	
AN OVERVIEW	15
Switching On the System	15
What Is GEM?	17
The Keyboard	17
Controlling the Mouse	18
Pointing and Clicking (Selecting)	20
Dragging	22
Controlling the Mouse Pointer with the Cursor Keys	22
Dialog Boxes and Alert Messages	23
Dialog Boxes	23
Alert Messages	23
Making a Backup ST Language Disk	24
What's on the ST Language Disk?	24
How to Format Your Blank Disk	25
How to Copy the ST Language Disk	27
Disks and Your Disk Drive	29
Single-Sided/Double-Sided	29
Write-Protecting Disks	30





CHAPTER 3: ICONS, WINDOWS, FILES, AND FOLDERS	33
Icons	33
The Floppy Disk Icons	33
The Trash Icon	33
Windows	34
Opening Windows	34
Moving Windows	36
Sizing Windows	37
Scrolling Windows	38
Updating Windows	39
Closing Windows	39
Managing Files and Folders	40
Types of Files	40
Opening (Running) Files	40
Copying Files	41
How to Copy the CONTROL.ACC and EMULATOR.ACC Files	41
Alternative Methods of Copying Files	43
Multiple Selections	44
Deleting Files	46
Renaming Files	46
Folders	47
CHAPTER 4: THE MENU BAR	53
Desk	53
Switching Your System On Without the Desktop Disk	54
Desktop Info	54
VT52 Emulator	55
Control Panel	55
Set RS232 Configuration	58
Install Printer	60
File	62
Open	62
Show Info	62
New Folder	63
Close and Close Window	64
Format	64





View	65
Show as Icons and Show as Text	66
Sort by Name, Date, Size, and Type	66
Options	67
Install Disk Drive	68
Install Application	68
Set Preferences	70
Save Desktop	71
Print Screen	71
CHAPTER 5: APPLICATIONS FOR YOUR ST COMPUTER	73
Programming Languages	73
ST BASIC	73
ST LOGO	74
Commercial Application Programs	74
Word Processors	74
Spreadsheet and Database Programs	75
Entertainment Programs	75
Telecommunications Software	76
Educational Programs	76
MIDI Software	76
APPENDIX A: TROUBLESHOOTING AND PREVENTIVE MAINTENANCE	77
APPENDIX B: CONNECTOR PINOUT SPECIFICATIONS	81
APPENDIX C: ST COMPUTER SPECIFICATIONS	85
GLOSSARY	87
INDEX	93
CUSTOMER SUPPORT	97







INTRODUCTION

Only a few years ago, the speed, memory, and graphics power of the ATARI® ST™ Computer were beyond the dreams of most computer enthusiasts. And today, there is no computer that offers the power and performance of the ST Computer at as reasonable a price.

The ATARI ST Computer system combines the latest microcomputer technology with an easily understood and simple-to-use working environment. There are no obscure commands to memorize, nor complicated procedures to follow. Computer operations are represented by pictures and words on the screen; to operate, you simply point to the item and click the mouse button.

The ST Computer's operating system, TOS™, has been permanently installed inside the computer. Along with ample Random Access Memory (RAM), TOS and the ST Computer have the capacity to handle the most complex word-processing tasks or the most detailed spreadsheet procedures. In addition, the ST Computer includes a built-in double-density ATARI MicroFloppy Disk Drive that can store up to 357,376 (349K) or 726,016 (709K) bytes on each disk, depending on the model you have.

The ST Computer offers extensive computing power and potential, including 512 different colors, three screen-resolution modes, an 80-column display, and expansive memory and disk storage. The ease of adding a hard disk, modem, printer, or music synthesizer greatly enhances the ST Computer's potential and allows you to adapt it to new and exciting uses.

How to Use This Manual

Operating your new computer is not difficult; however, you should learn to use it correctly. This manual, designed for computer users from novices to seasoned experts, tells you how to do that. It is intended to be read from beginning to end, proceeding step by step from the simplest to the most advanced operations and procedures.

Most important is that you make a copy of your ST Language disk (Chapter 2) before beginning to work with your computer in earnest. Once you have a backup copy of the disk, you won't have to worry about damaging its contents.





The following outline summarizes the contents of this manual:

Chapter 1, Getting Started, familiarizes you with the parts and features of the computer and how they work. It explains how to unpack the computer and connect all system components, and surveys the major features and available options relating to the main unit.

Chapter 2, Operating Your ST Computer: An Overview, introduces you to the GEM™ Desktop and describes how to manipulate it. The chapter also describes how to copy the ST Language disk.

Chapter 3, Icons, Windows, Files, and Folders, explains how to manage your information, both on screen and on disk, using the GEM Desktop.

Chapter 4, The Menu Bar, details all Menu Bar headings and the menu options they supply.

Chapter 5, Applications for Your ST Computer, describes the major types of applications available for your ST Computer, introducing you to the world of programming languages, word processors, and database and graphics programs that run on your ST Computer.

Appendix A, Troubleshooting and Preventive Maintenance, contains a rundown of problems you may encounter while setting up or operating your ST Computer, and offers solutions. You'll also find helpful hints regarding the care and maintenance of your computer system.

Appendix B, Connector Pinout Specifications, details the pin assignments of the ST Computer ports.

Appendix C, ST Computer Specifications, summarizes the major features and requirements of the computer.

The **Glossary** defines common technical terms used in association with the ST Computer and within this manual.

The **Index** is included for your reference.





Customer Support tells you where to find more information about your ST Computer.

Paragraphs marked **Warning** or **Note** appear throughout the manual. Warnings alert you to potential problems and suggest ways to avoid them. Notes contain useful hints and other information relevant to the topic at hand.







CHAPTER 1 GETTING STARTED

Unpacking Instructions

Using both hands, carefully lift the computer in its foam packing out of the carton. Remove the foam packing and plastic bag, and place the computer on a firm, level surface. Inside the carton you should find these items:

- ATARI ST Computer
- Mouse
- Power Cable
- ST Language Disk
- ST Owner's Manual

Before going on, make sure you have received all those items. If anything is missing, contact your ATARI Computer retailer.

Note: Save all packing materials for shipping and storing your computer.

Connecting the System

Your ST Computer is a sophisticated piece of electronic equipment and you must choose a proper working environment for the system. Avoid places that expose the components to dust, grease, extreme temperatures, or high humidity. An environment you'd consider suitable for a stereo system or television should also serve your computer well. Arrange the components securely on a firm, level surface, then follow the instructions in this chapter.

Note: See Appendix A, Troubleshooting and Preventive Maintenance, for information on caring for your ST Computer system.





The Computer and Disk Drive

Your ST Computer includes a double-density Atari MicroFloppy Disk Drive built into its right side panel. The disk drive is your primary means of storing and retrieving information. When you connect the power cable to your computer, you are also providing the power source for your disk drive. When the red light on the computer's front panel is illuminated, power to the computer and the drive is switched on. When the drive is "busy" (working to store or retrieve information), the light beside the computer's front panel label illuminates and the drive whirs.

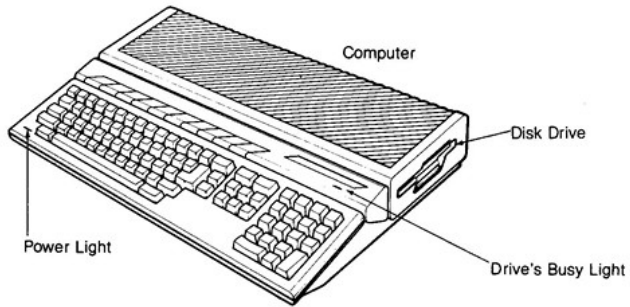

Make sure the computer is switched off. Plug one end of the power cable into the jack marked "Power" on the back panel of your computer. Now plug the cable's electrical plug into a wall outlet or power strip.

Warning: Be certain to remove the protective cardboard insert from your drive before switching on the power.

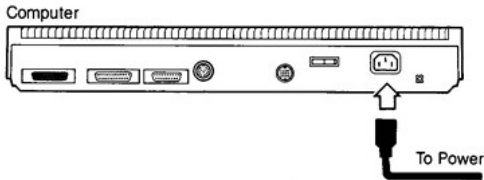



The Mouse

You will use the mouse to control much of what you do with your computer. You should connect it now.

To connect the mouse, plug its cable into the port marked "0" on the right underside of the computer.

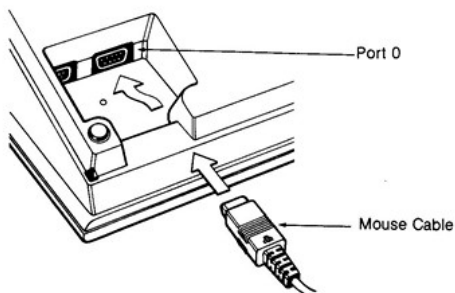

The Video Display

The display screen allows you to see what's going on. Without a video display screen, your computer has no way of communicating with you, nor can you effectively communicate with it. Depending on your ST Computer model, you may have the option of using a television as the video display screen for your computer. Keep in mind, however, that a monitor delivers a much sharper display than a television. Also, a television cannot display the high-resolution images your computer is capable of producing.

Monitor

If you have either an ATARI High-Resolution Monochrome Monitor or an RGB Analog Color Monitor, plug its video cable into the jack labeled "Monitor" on the back of the computer. Connect the monitor's power cable and plug it into a wall outlet or power strip.



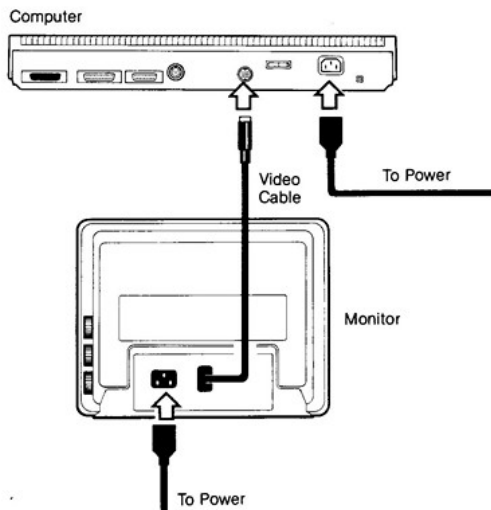

Note: Consult the manual that came with your monitor for further information.

Television

If the ST Computer model you have is equipped with a TV port, you can use a television as the computer's video display. To do that, connect the TV cable (supplied with your system) to your system and to your TV UHF aerial socket. Tune your television to channel 36.





A Second Disk Drive

In addition to the disk drive built into your computer, you may connect an additional drive to your computer system. A second drive enhances the convenience of data storage and retrieval.

To connect a second disk drive, follow these steps:

1. Make sure the computer is switched off, then plug one end of the drive's interface cable into the jack labeled "Floppy Disk" on the back of the computer. Plug the other end into the port marked "In" on the back of the drive.
2. Make sure the disk drive is switched off, then insert the AC power adapter's round plug into the jack labeled "Power" on the back of the disk drive. Insert the power adapter's electrical plug into a wall outlet or power strip.

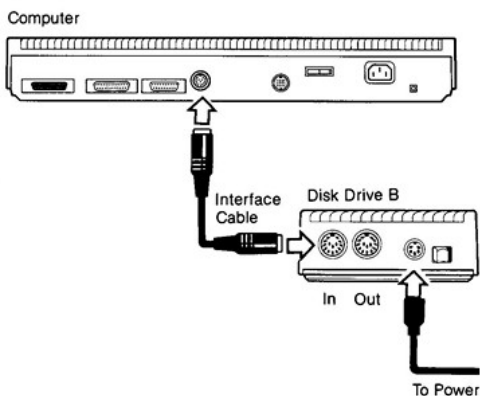

Note: You can connect a maximum of one external floppy disk drive to your ST Computer. The system always refers to your internal drive as Drive A. Your external drive is Drive B.





Connecting a 3-Pin Plug to the Mains Lead

This unit is designed to operate on ~240V 50 Hz mains supply.

The wires in this mains lead are colored in accordance with the following code:

Green/Yellow	— Earth (E)
Blue	— Neutral (N)
Brown	— Live (L)

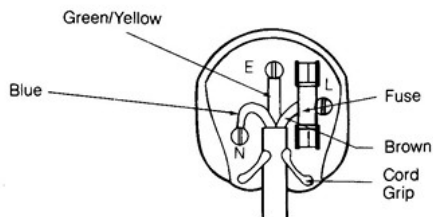

If the colors of the wires in the mains lead of this appliance do not correspond with the colored markings identifying the terminals in your plug, proceed as follows:

The wire colored GREEN/YELLOW must be connected to the terminal in the plug marked by the letter E or by the safety earth symbol \equiv , or colored GREEN, or GREEN/YELLOW.

The wire colored BLUE must be connected to the terminal marked with the letter N or colored BLACK. The wire colored BROWN must be connected to the terminal marked with the letter L or colored RED.

If a 13-amp (BS1363) plug is used, a 3-amp fuse must be fitted, or if any other type of plug is used, a 3- or 5-amp fuse must be fitted either in the plug, adaptor, or on the distribution board.





Ports

The Back Panel

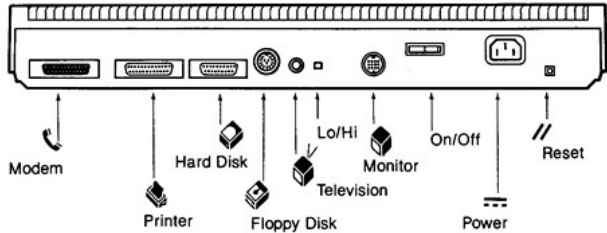

Modem

Any industry-standard RS232 modem may be connected to your computer through this port. Connect the modem's interface cable from the modem to this port. Your computer uses a modem to transmit and receive information to and from other computers via a telephone line. With a modem in your system, you can hook into a variety of electronic information and mail services, communicate with the computer at work, or talk to a friend's computer. You can also connect a serial printer or any other RS232 device through the Modem port.

Printer

An ATARI ST Printer connects to your computer through this port. Connect the interface cable that came with your printer to this port, then to the printer. The Printer port is an industry-standard parallel interface, so almost any parallel printer can be attached here.

Hard Disk

An ATARI Hard Disk Drive attaches to your computer through this port. Simply connect the interface cable that came with your hard disk to this port, then to the hard disk. A hard disk drive can store much more information and transmit that information much faster than a floppy disk drive. Your hard disk drive is Drive C.





Floppy Disk

A second disk drive (Drive B) can be connected to your ST Computer through this port.

Television

If your ST Computer has a built-in TV modulator, you can use a television as your video display. The cable connecting the computer to the television is connected to this port.

Lo/Hi Switch

The Lo/Hi switch selects the channel that is weakest in your area for the computer's video display. This switch is only present on ST Computer models with a built-in modulator.

Monitor

An ATARI RGB Analog Color Monitor or an ATARI High-Resolution Monochrome Monitor can be attached to your computer through this jack.

I O On/Off

This switch turns the computer on and off; 1 is on, 0 is off.

Power

This plug connects the computer to the power source.

// Reset

This button restarts the computer without switching it off and on. Restarting the computer this way is known as a "warm" start.





The Left Side Panel

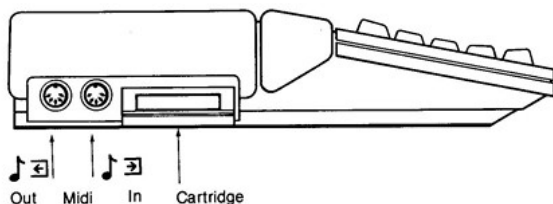

Midi Out/Midi In

MIDI stands for Musical Instrument Digital Interface. The two MIDI ports give your computer access to the latest generation of electronic musical instruments. The Midi In port allows the computer to monitor a synthesizer or any other MIDI-equipped instrument. The Midi Out port lets the computer control an instrument's digital interface, letting you play complex compositions while changing the volume, tempo, and instrumentation. Using the MIDI interfaces, your computer can become a sophisticated studio recorder that lets you create music one track at a time.

Cartridge

Software programs for ST Computers that come in cartridge form are inserted in the cartridge slot. Cartridge programs load instantly, and because they are external, they do not use any of the computer's memory in order to load. Up to 131,072 (128K) bytes of program information can be contained on a single cartridge. The system treats the cartridge as Drive c.





The Right Side Panel

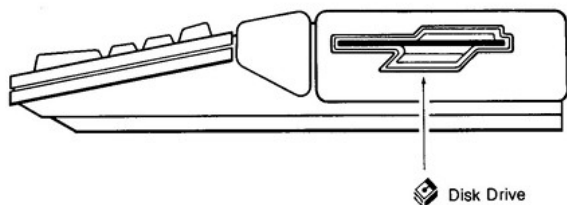

Disk Drive

The built-in ATARI MicroFloppy Disk Drive is double-density, and either single- or double-sided, depending on the ST Computer model you have.

The Right Underside

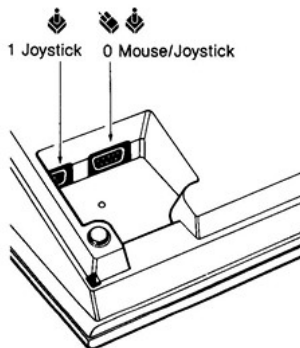

Mouse & Joystick

The mouse connects to your computer through the Mouse/Joystick port 0. ATARI-compatible joysticks can also be connected through either port 0 or 1. Joysticks are used when playing computer games; they allow you to control the action of the game on the screen.





CHAPTER 2

OPERATING YOUR ST COMPUTER: AN OVERVIEW

Switching On the System

Once you have connected all the components, you are ready to switch on the power to your computer system. Follow these steps:

1. Hold the ST Language disk by its plastic casing with the label facing up and the metal end towards the slot on the disk drive. Slide the disk gently forward into the drive opening until it clicks into position. The disk should be completely inside the drive when properly installed.

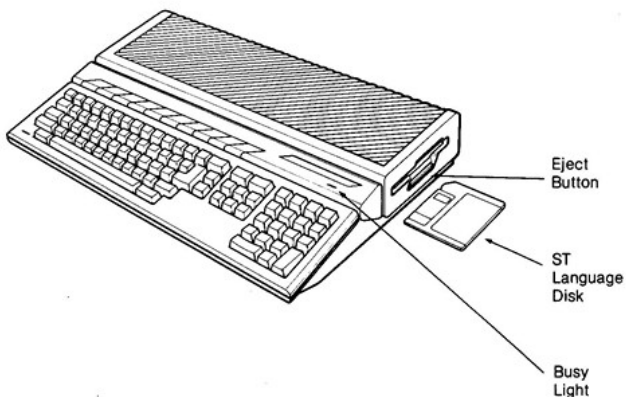



2. Switch on your monitor, a second disk drive (if you have one), then your computer (always switch your computer on last). The drive's busy light goes on and the drive whirs, while the Bee icon appears and some of the disk's information loads into your computer. (Whenever the computer transfers or retrieves information from the disk drive, the screen displays the Bee icon.) After a few moments, your screen looks like this:

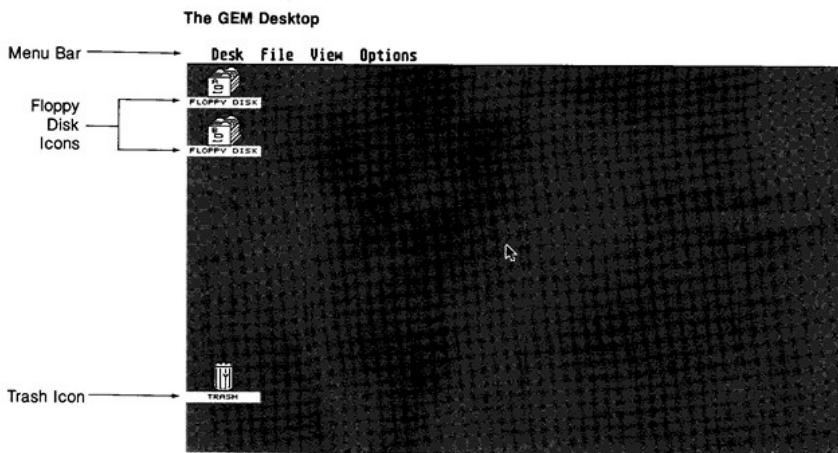

This is the GEM Desktop. It is the starting point for almost everything you do with your ST Computer. As you become acquainted with your computer system, the GEM Desktop and its features will serve as an important point of reference for you.

Note: If the GEM Desktop fails to appear on your screen, switch the computer off and make sure that your video display is switched on, that the ST Language disk is correctly inserted inside the drive, and that all cable connections are proper and secure. Try switching the system on again. If the problem persists, refer to **Appendix A, Troubleshooting and Preventive Maintenance**.



What is GEM?

GEM stands for Graphics Environment Manager, which is just a fancy way of saying that the desktop conveys and manages information by means of graphic images and words instead of words alone. The opening screen display is called the "Desktop" because it's graphically modeled to imitate and function as one's home study or office desk.

The GEM Desktop consists of the Menu Bar along the top of the screen, three icons (pictures) along the left side, and the remaining screen space. The Menu Bar gives you access to the utilities and applications available from the GEM Desktop. The Floppy Disk icons allow you to control and manipulate the information stored on your disks. And the Trash icon lets you dispose of your unwanted information. (See Chapter 3 for an explanation of the Floppy Disk and Trash icons. See Chapter 4 for a detailed presentation of the Menu Bar and its contents.)

The Keyboard

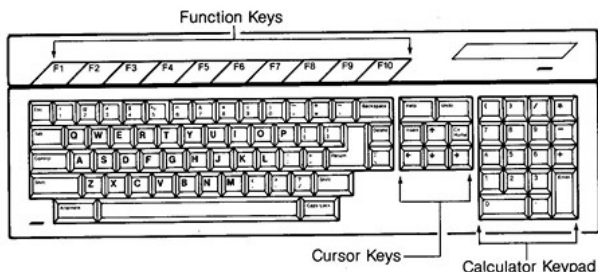

The central part of your ST Computer keyboard is arranged much like a conventional typewriter keyboard. This is because much of what you'll do with the computer will involve typing; for instance, writing letters or reports. These keys function just as on a typewriter. The [S] key produces the letter "s" on your screen; pressing [Shift] [S] produces the capital letter "S."



But computers, because they are not mechanical, require special keys to replace those keys on a typewriter that perform mechanical functions. One example is the [Return] key on your computer keyboard. It replaces the carriage return lever (or key) on a typewriter, and returns you to the screen's left margin. Another example is the computer's set of cursor ("arrow") keys. The cursor is a graphic point on the screen that keeps your place when you type with the computer. The cursor keys allow you to control the movement of the cursor on your screen.

The [Esc], [Control], and [Alternate] keys work much like the [Shift] key, in that they often change the meaning of a second key to produce special instructions or codes. Along the top of the keyboard are the function keys, [F1] through [F10]. These keys have no set meaning, though many software applications use them to perform special operations.

Note: Throughout this manual, letters or words enclosed by square brackets ([]) represent keys on your ST Computer keyboard. Some functions require that you simultaneously press two or three keys; in that case, the keys are listed serially.

Controlling the Mouse

The mouse is the main device for moving around and manipulating the desktop. It is a small, rectangular box with two buttons on top, a ball underneath, and a cable running from the mouse to Mouse/Joystick port 0 on the computer.

The mouse detects motion (direction, distance, and speed) through the movement of its ball as it rolls over your working surface. On the screen, a small arrow called the "mouse pointer" mirrors the movement of the mouse. The mouse allows you to position its pointer anywhere on the GEM Desktop. You use the left mouse button to "select" items on the desktop; you will always use the left button within the desktop. The right mouse button is used with some application programs.





To understand further how the mouse operates, situate it on a flat, clean surface (your computer desk or tabletop) so that the side with the cable is facing the screen. Now move the mouse around — left, right, forward, backward, in circles. Practice moving the pointer around the desktop so you get the feel of the mouse and how it controls the pointer's movement.

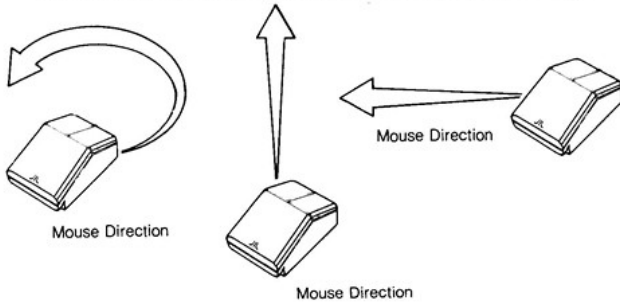
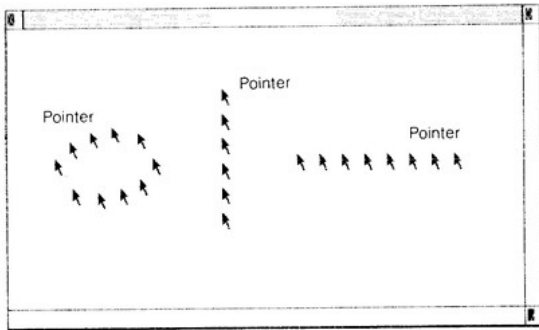



Pointing and Clicking (Selecting)

When you "select" an item on the GEM Desktop, you tell the computer that you want to do something with the file or function that the item represents. Use the mouse pointer to point at the item you wish to select. Then select the item by "clicking" the left mouse button.

Note: To customize the clicking rate and responsiveness of the mouse button, see **Control Panel** in **Chapter 4**.

Selecting an Icon

To point at an icon, position the tip of the pointer on that icon.

Positioning the Mouse Pointer

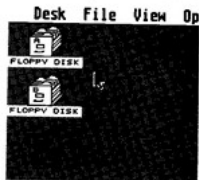

Incorrect



Correct



Incorrect

To select an icon, click and immediately release the left mouse button.

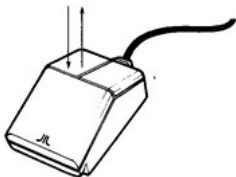

Try pointing at and clicking on one of the icons. When you click on an icon, it reverses shading (highlights) to indicate that it has been selected.

To cancel your selection, move the pointer anywhere else on the GEM Desktop and click the left mouse button. Selecting a second icon before canceling the first selection automatically cancels the first selection. (See **Multiple Selections** in **Chapter 3** for techniques on selecting more than one item at a time.)





Selecting an Icon



Canceling the Selection

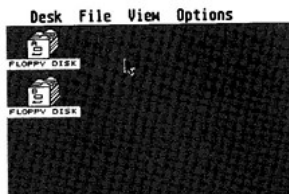

Selecting a Menu Heading and Option

To point at a menu option, move the pointer to one of the Menu Bar's headings. The appropriate menu immediately drops down. Now move the pointer to the menu option you want to select. Notice that the items reverse shading as you point at them. To select a menu option, click on that option when it's highlighted.

Positioning the Mouse Pointer on a Menu Bar Heading

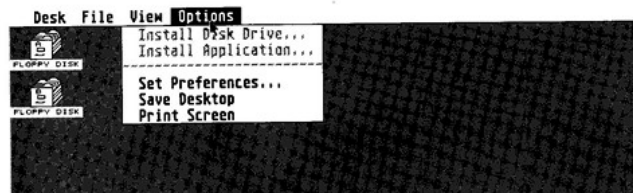

Positioning the Mouse Pointer on a Menu Option

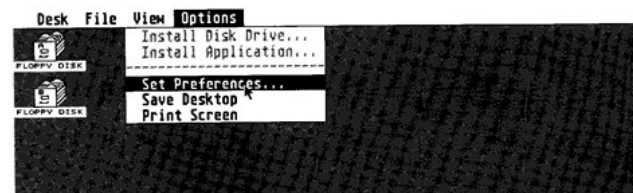



To cancel without making a selection, move the pointer outside the menu and click the left mouse button. Also, moving to a second menu automatically cancels the first menu.

Dragging

Another important mouse technique is "dragging." When you drag an icon, you move it from one place to another on the desktop. To drag an icon, select it, then press and hold the left mouse button while you move the mouse pointer. A "ghost" (outline) of the icon follows the pointer. When you release the button, the icon jumps to its new location, appearing at the last position of the ghost icon.

Dragging an Icon

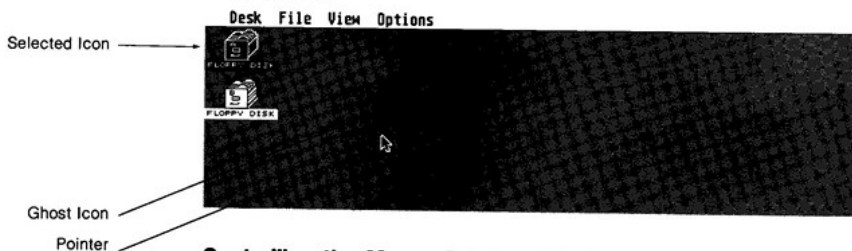

Controlling the Mouse Pointer with the Cursor Keys

You can also use the cursor keys to move the pointer around the desktop. The list that follows shows the keystroke combinations that control the pointer's movement on screen without using the mouse.

[Alternate] [any cursor key] moves the pointer eight pixels (screen dots) in the direction indicated by the cursor key.

[Alternate] [Shift] [any cursor key] moves the pointer one pixel.

[Alternate] [Insert] selects an icon. This combination is the same as pressing the left mouse button.

[Alternate] [Insert] [any cursor key] drags an icon.

[Alternate] [Clr Home] performs right mouse button functions.

Note: To adjust the speed and responsiveness of the cursor keys, see Control Panel in Chapter 4.



Dialog Boxes and Alert Messages

Dialog Boxes

Whenever the ST Computer needs to communicate with you, it displays a Dialog Box at the center of the GEM Desktop. Dialog Boxes establish a dialog between you and the computer. For example, the Dialog Box below requests information from you so that a certain procedure may be completed.

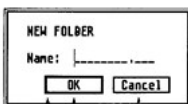

Enlarged Border Dialog Buttons

To execute your action from a Dialog Box, point at one of the Dialog buttons and click the left mouse button. If a Dialog button has an enlarged border, you can simply press [Return] on the ST Computer keyboard rather than clicking on that button.

Alert Messages

Alert Messages are Dialog Boxes punctuated with stop signs, question marks, or exclamation points. Alert Messages warn you that the operation you are performing or about to perform has potentially dire consequences, or that it is improper or impossible.

When you see an Alert Message, such as the one below, follow its instructions and click on the appropriate Dialog button inside.

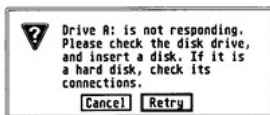

Making a Backup ST Language Disk

It is imperative that you make a backup copy of your ST Language disk. If something should happen to the ST Language disk that came with your system, you would be unable to access many of the desktop's features.

To make a backup of your ST Language disk you will need a new, blank, 3½-inch disk. (The disk may be either single- or double-sided.) Disks can be purchased at any computer retailer. The duplication procedure is simple, and will begin to acquaint you with the workings of the GEM Desktop.

What's on the ST Language Disk?

Before you begin the duplication procedure, take a look at what's on the ST Language disk. As you will see, the ST Language disk contains recorded information arranged in files. CONTROL.ACC and EMULATOR.ACC are the Desk Accessory files. The bulk of the information on the disk is files for running the programming language, ST BASIC™.

To view the files on the disk, follow these steps:

1. With the ST Language disk in your built-in drive (Drive A) and the GEM Desktop displayed, point at the Floppy Disk A icon and click the left mouse button (you are "selecting" Drive A).
2. Point at the File heading on the Menu Bar, then move the pointer until the word "Open" reverses shading. Click the left mouse button once (you are "selecting" the Open utility).
3. Your "window" to the contents of Drive A now opens. The disk's files are displayed as icons; each file (icon) has a name. Just take a moment to see that indeed there are files on your ST Language disk.

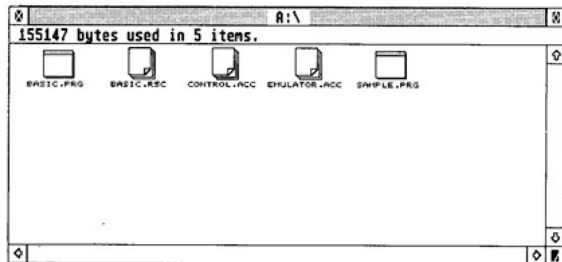



4. Now close Drive A's window. Move the pointer to the File heading once again. Move down the menu until "Close" reverses shading, then click the left mouse button. Drive A's window disappears.

How to Format Your Blank Disk

Before you copy the ST Language disk, you must prepare the blank disk to receive information. This procedure is called "formatting." To format your blank disk, follow the steps below and read the prompts that appear in the Dialog Boxes on your screen.

1. If you have one disk drive, remove the ST Language disk from your drive by pressing the drive's eject button. Place the ST Language disk aside, and insert your new blank disk into the drive.

If you have two disk drives, insert the ST Language disk into Drive A and the blank disk into Drive B (your external drive). With two drives, you can keep the ST Language disk in Drive A and the blank disk in Drive B during the formatting and duplication processes.

2. If you have one drive, select the Floppy Disk A icon, then select Format from the File heading on the Menu Bar (click on Format).

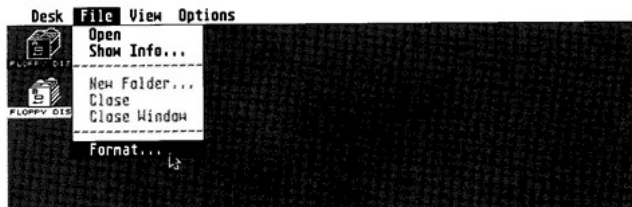

If you have two disk drives, select the Floppy Disk B icon, then select Format from the File heading on the Menu Bar (click on Format).





3. The GEM Desktop now displays the following Alert Message:

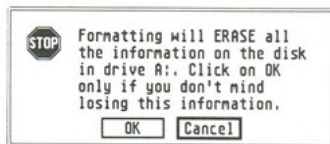

As a safeguard, this message warns you that formatting will erase any information previously stored on the disk. Since you are beginning with a blank disk, the warning doesn't apply. Click on the OK button and proceed to the Format box.

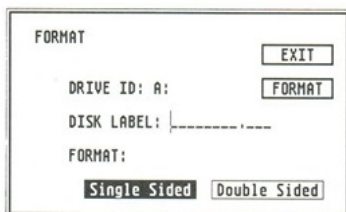

4. Make sure the single-sided box is shaded, then click on the Format button. (Do not label your disk.)
5. While the disk is being formatted, the computer monitors the process in the Format Working box.

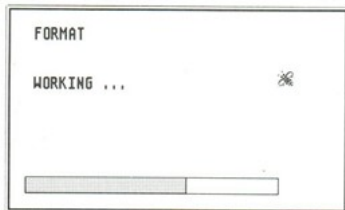



Your blank disk is now formatted and can hold 357,376 bytes of information, which is more than enough to copy the ST Language disk. Click on the OK button. You will return to the Format box. Click on the Exit button to return to the GEM Desktop.

Note: If your computer does not report that the formatted disk can hold 357,376 bytes of information, the disk may be defective. Try formatting it again. If the problem persists, place a new disk in the drive and format it.

How to Copy the ST Language Disk

To copy the ST Language disk to your now formatted blank disk, follow these steps. If your ST Language disk has a write-protect tab, move it to the open (protected) position (see **Write-Protecting Disks** later in this chapter).

1. If you have one disk drive, insert the ST Language disk into the drive, select Floppy Disk A with the mouse pointer and drag it on top of the Floppy Disk B icon. When the Floppy Disk B icon reverses shading, release the left mouse button. (If you are working with one disk drive, copying to Disk B simply means that your drive will function as both Drive A and Drive B in the duplication process.)

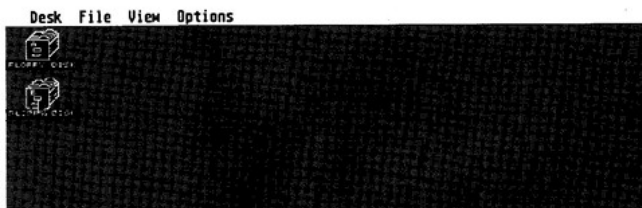

If you have two disk drives, be sure the ST Language disk is in Drive A (your internal drive) and the formatted disk is in Drive B (your external drive). Then select Floppy Disk A with the mouse pointer and drag it on top of the Floppy Disk B icon. When the Floppy Disk B icon reverses shading, release the left mouse button.

2. As a precaution, you will see an Alert Message warning you that copying Disk A to Disk B erases all information on Disk B. Again, since you are beginning with a blank disk, the warning doesn't apply. Click on the OK button. You now see the Diskcopy box.



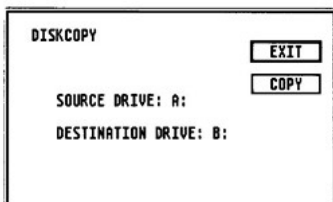

Click on the Copy button and follow the prompts to finish the copying process. You will be instructed to switch disks, if working with one disk drive, until the copying process is complete. The computer monitors the duplication process in the Diskcopy Working box.

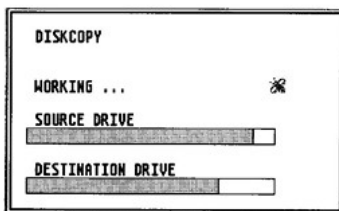

The "source" disk is the disk you are making a copy of. The "destination" disk is the disk you are copying to.

3. When the procedure is complete, you will see the Diskcopy box again. Click on the Exit button to return to the GEM Desktop. Put the original ST Language disk in a safe storage place. Using a stick-on paper label, label the copy's plastic housing "Working ST Language." From now on, use your Working ST Language disk whenever using your computer.

Note: You were previously instructed not to name your newly formatted disk in the Format box because making a disk-to-disk copy erases all information on the destination disk, including the disk label, so the effort would have been pointless. Under other circumstances, you may of course name disks in the Format box. For more information, see **Format** in **Chapter 4**.





Disks and Your Disk Drive

Most of the information you load into your ST Computer will be stored on 3½-inch microfloppy disks. Disks and your disk drive enable you to load information into the computer, as well as store programs and other information that you create with your ST Computer.

Note: See Appendix A, *Troubleshooting and Preventive Maintenance*, for information on caring for your disks and disk drive.

Single-Sided/Double-Sided

The disk drive built into your ST Computer is either a single- or double-sided drive, depending on the ST Computer model you have. Single-sided drives can record and read information on single-sided disks. Double-sided drives can record and read information on double-sided disks. Single-sided disks have one recordable side, whereas double-sided disks can accept recorded information on two sides. ATARI single-sided Micro Floppy Drives allow you to store up to 357,376 bytes on one single-sided disk. ATARI double-sided Micro Floppy Drives allow you to store up to 726,016 bytes of information on one double-sided disk.

If you have a double-sided drive, you must use double-sided disks when using the double-sided format option. A double-sided drive will also accept single-sided disks. It is important that your drive be able to do this because most of the commercial software programs for your ST Computer will be on single-sided disks. You may format double-sided disks in the single-sided format, though the disk's other side will be unable to record any data.

You cannot directly copy a single-sided disk to a disk that has been formatted as a double-sided disk, nor vice versa. The ST Language disk that came with your system is single-sided. That is why, if you have a double-sided drive, you had to format your blank disk as single-sided, even though your drive is double-sided and the new disk you used may have been double-sided. Remember, if you have one double-sided disk drive and one single-sided disk drive in your system, you cannot do a disk-to-disk copy from a double-sided disk to a single-sided disk, nor vice versa. However, by unplugging one of your drives then switching on your system, you'll be able to do a disk-to-disk copy—the lone disk drive will act as both source and destination drive.

To find out more about how to get the information from a formatted double-sided disk to a formatted single-sided disk (and vice versa), see *Copying Files and Folders* in Chapter 3.



Write-Protecting Disks

When you write-protect a disk, you prevent information from being "written to" the disk. To "write to" means to put information on the disk; the computer and disk drive work together to record information on the disk. (Similarly, to "read" a disk means to retrieve information recorded on the disk; the drive and computer work together to "load" information into the computer's memory.)

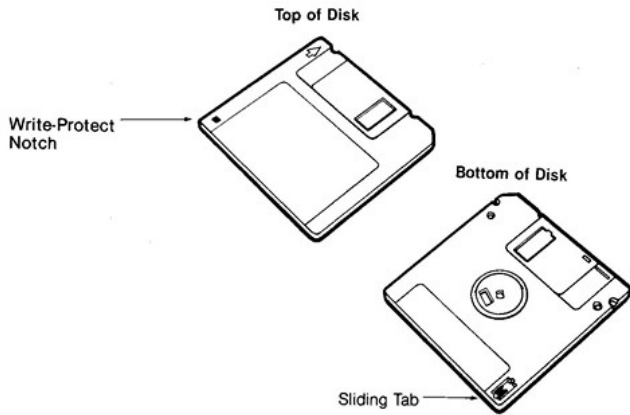

Most disks have a small write-protect notch at the lower left-hand corner of their plastic casing. Turning the disk over, you see a small, sliding tab. To write-protect a disk, slide the tab until you can see through the notch.

While write-protected, a disk cannot be formatted, erased, or written to. You can move the write-protect tab back to the unprotected position any time you wish to record information on the disk.





Commercial program disks usually do not have write-protect tabs. These disks are permanently write-protected as a safety precaution. You cannot format, erase, or write to a permanently, write-protected disk.

Before duplicating a disk or copying files from one disk to another, it is recommended that you write-protect the disk you are duplicating or copying files from. Doing so safeguards you against mistakenly inserting your original disk when the drive is ready to write information on the duplicate. Such confusion is likely when you are using a single disk drive to duplicate disks or copy files.







CHAPTER 3 ICONS, WINDOWS, FILES, AND FOLDERS

Icons

The Floppy Disk Icons

When you first switch on your ST Computer, the GEM Desktop displays two Floppy Disk icons in the upper left-hand corner.



The icons themselves don't look like disk drives; instead, they resemble file drawers. Your disks and drive constitute the computer's filing system—the way you store and retrieve information when working with the ST Computer. The Floppy Disk icons allow you to view, control, and manipulate the files stored on the disks.

The Trash Icon

The Trash icon works like a real trash can. When you want to delete a file from a disk, drag the item to the Trash icon. The Delete box then appears, and you can instruct the computer to erase the file.



Warning: The Trash icon works more like an incinerator than a trash can. Once you throw something away, it's gone forever. You can't reach back in and pull it out again.





Windows

On most computers, all the activity takes place on the full video display screen. On the ST Computer, much of the activity takes place in areas called "windows." Windows are miniature screens within the larger video screen that display the files on your disks, among other things. The GEM Desktop allows you to have up to four windows open at a time.

Note: The open windows in this manual are examples only. The copy you made of your ST Language disk may show a different number of bytes used and different files.

Opening Windows

There are two methods of opening a window. The first method is selecting a Floppy Disk icon, then pointing at and clicking on the Open option under the File Menu.

The second method is called "double-clicking." It is both faster and more convenient than using the Open option. You simply point at a Floppy Disk icon and quickly click the left mouse button twice. With the GEM Desktop displayed and your Working ST Language disk in Drive A, try double-clicking on Floppy Disk A to open its window.

Once Floppy Disk A opens, you'll see its file icons and their names, along with the window utilities at the window's top, right, and bottom borders.



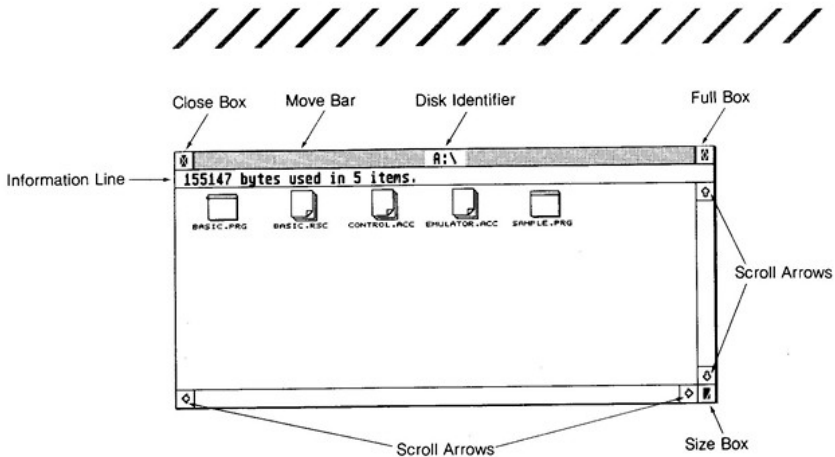

The Disk Identifier tells you which disk you've opened (either A or B). The Information Line tells you the sum of the bytes used and in how many items. (To view the remaining storage capacity of a disk, refer to **Show Info** in **Chapter 4**.)

A window is active when the Move Bar (along the top edge) is shaded and the Scroll Bars (along the right and bottom edges) contain the Scroll Arrows and utility boxes. An active window can be sized, moved, dragged, or have its contents scrolled. Only one window can be active at a time. If you have more than one window open, you can make any open window active by pointing at and clicking on it.





Moving Windows

You can move a window to any position on the GEM Desktop by using the Move Bar located on the top edge of a window. To move a window, point at the Move Bar, press and hold the left mouse button, then drag the window to any location on the GEM Desktop and release the button. The window pops into its new position.

Moving a Window

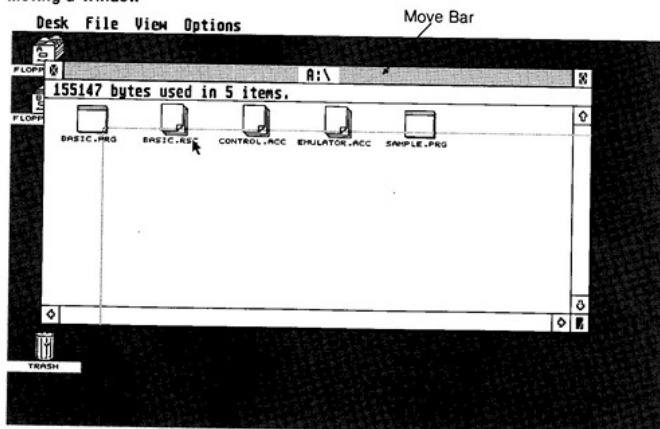

Moving windows is especially useful when you need to position more than one open window on the GEM Desktop (for example, as you copy files from one window to another).





Sizing Windows

You can make a window any size you want. First point at the small box called the Size Box in the lower right-hand corner of the window, then press and hold the left mouse button. Now drag the Size Box in the desired direction—move down to lengthen the window; up to shorten it; right to widen it; and left to narrow it.

Sizing a Window

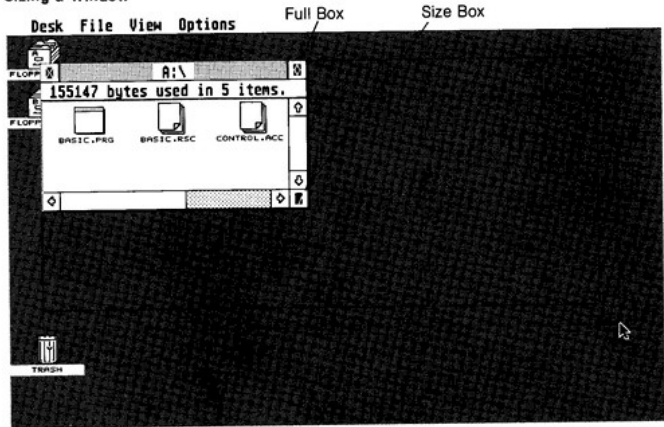

Sizing windows is also useful when you need to position more than one open window on the GEM Desktop (for example, as you copy files from one window to another).

A quick way to enlarge a window is to point to and click on the small box called the Full Box in the upper right-hand corner of the window. When you click on this box, the window expands to fill the entire screen. Clicking on the Full Box again returns the window to its previous size, shape, and position on the GEM Desktop.





Full Screen Window

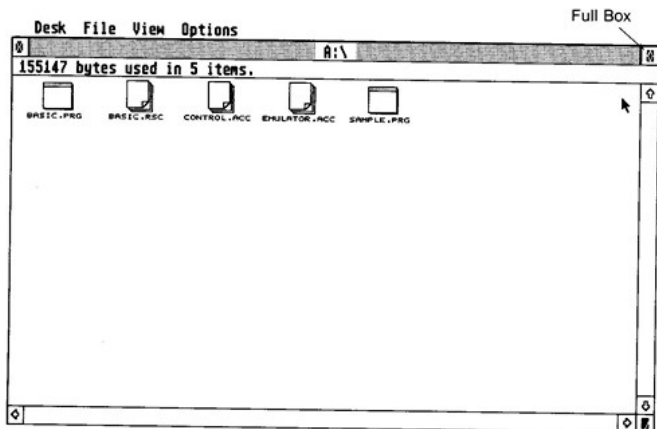

Scrolling Windows

If you want to see items that may be cut off at the edges of a window, but there isn't enough room to enlarge that window, you can "scroll" the contents of the window. The two Scroll Bars—one along the right and the other along the bottom edge of the window—will scroll the contents to the right or left, or up and down.

A portion of the Scroll Bar will be shaded when files are hidden that you might not otherwise notice or remember. If shaded, the arrows indicate in which direction the unseen items sit. The unshaded portion of the Scroll Bar is proportionate to the fraction of the total that you currently see; likewise, the shaded portion is proportionate to the fraction of the total that is hidden. If no part of the Scroll Bar is shaded, then no items are hidden from view.

To scroll, point at the arrow indicating the direction of the hidden contents, then click the left mouse button. Clicking on the arrows moves the display by one "unit" (icon).



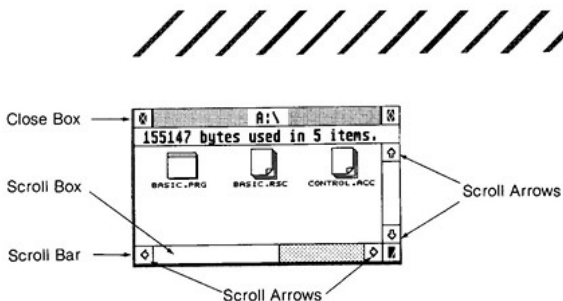

There are two other ways to scroll the contents of a window. One is to drag the Scroll Bar's unshaded portion up or down (vertical Scroll Bar) or left or right (horizontal Scroll Bar). A second method is to click on the shaded areas of the Scroll Bars. Clicking on the shaded areas moves the display one "view-unit" (the currently visible area's size).

Updating Windows

Under certain circumstances, a directory window's display may not match the actual files on the disk in that drive. For instance, if you have Floppy Disk A's window open (presumably displaying the files on a certain disk), then you insert a different disk in the drive (presumably containing different files), the directory display will not automatically be updated simply by inserting the new disk. To update an open and active window's directory, press [Esc].

Closing Windows

To close a window, click on the small box called the Close Box in the upper left-hand corner of the window. The window will immediately close and return you to another window, if one is on screen, or to the GEM Desktop. (For more information, see Close and Close Window in Chapter 4.)





Managing Files and Folders

Types of Files

Your ST Computer stores two types of files on disk: data files and program files.

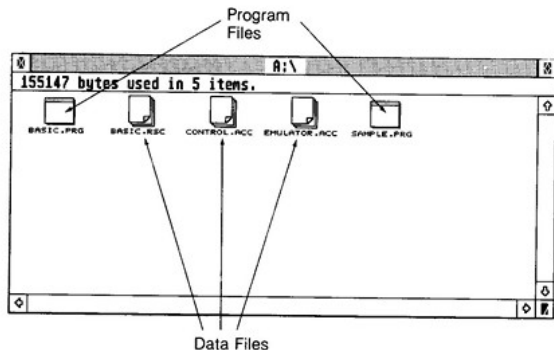

The icons that look like sheets of paper with a corner folded over represent data files. These files contain data that are used by applications programs.

The icon without the folded corner is a program file. Program files contain programs.

A third icon, not shown here, looks like a file folder. Folders may contain several files, and provide a way to group related files on your disks. (For more information, see **Folders** later in this chapter.)

Opening (Running) Files

There are two methods of opening a file from the GEM Desktop. The first method is to select the file's icon, then point to and click on the Open option under the File Menu. The second method is to double-click on the file's icon.





Try double-clicking on the program file "SAMPLE.PRG." The icon will open into a window, and the program will start. This demonstration program lets you practice your window sizing, moving, and closing skills. To exit from the program, close the program's window. (For more information on opening program files, see Chapter 5.)

You can only print or display a data file; a Dialog Box informs you if one is ever opened.

Copying Files

With many computers, copying files is a complicated process involving numerous commands. On the ST Computer, to copy any type of file, you select that file's icon and drag it to where you want to put the copy. If you want to copy a file onto another disk, simply drag the file icon to the icon for that disk, making sure the file's icon is on top of the disk's and that the disk's icon reverses shading.

How to Copy the CONTROL.ACC and EMULATOR.ACC Files

Your Working ST Language disk contains files not essential to the running of the GEM Desktop. The bulk of information on the disk is files that run the programming language, ST BASIC, that you received with your ST Computer (see Chapter 5). But the disk also contains two desktop files that you will find handy to have on a separate disk. They are the CONTROL.ACC and EMULATOR.ACC files.

To copy the two files, follow these steps:

1. Format a new, blank disk. In the Format box, name the disk "Desktop." You can format it for single- or double-sided recording. (To review the format process, see **How to Format Your Blank Disk** in Chapter 2.)
2. Remove the formatted disk and insert your Working ST Language disk into the drive. (If you have two disk drives, you can leave both disks installed.) Now double-click on Floppy Disk A to open its window.
3. Drag the CONTROL.ACC icon onto the Floppy Disk B icon; the Floppy Disk B icon must reverse shading. Now release the left mouse button. (Or, try selecting and dragging both files to Floppy Disk B at once; see **Multiple Selections** later in this chapter.)



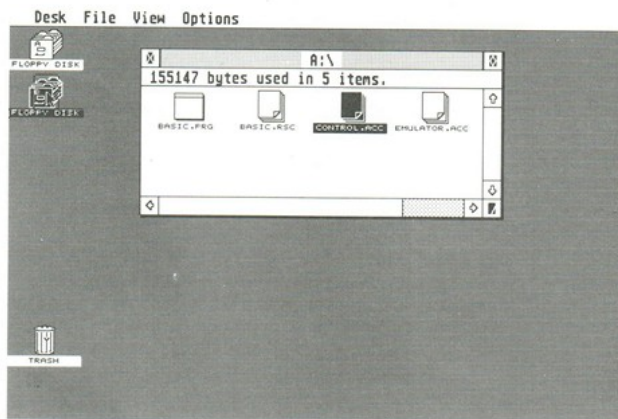

4. The GEM Desktop now displays the Copy box.

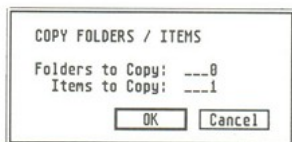

Click on the OK button. The Dialog Boxes that follow instruct you when to switch disks, if necessary.

5. Repeat steps 3 and 4 to copy the EMULATOR.ACC file.

Whenever you switch on your system, you can now use this new disk in your drive. You no longer need your Working ST Language disk when switching on the system (unless, of course, you want to run the programming language). The new disk has all the information your ST Computer needs to provide the full set of ST Computer Desk Accessories. Label the new disk "Desktop." (For more information, see **Switching Your System On Without the Desktop Disk and Save Desktop** in Chapter 4.)

Note: When you copy to a Floppy Disk icon, if the disk's window is open at the time of copying, it will not be updated when copying is complete. To update the disk window, activate it and press [Esc].



Alternative Methods of Copying Files

There are other methods of copying files from one disk to another. One way is to drag a file from one open window to another; for instance, dragging a file from Floppy Disk A's open window to Floppy Disk B's open window. This will copy the file from Floppy Disk A to Floppy Disk B.

Dragging a File from One Window to Another

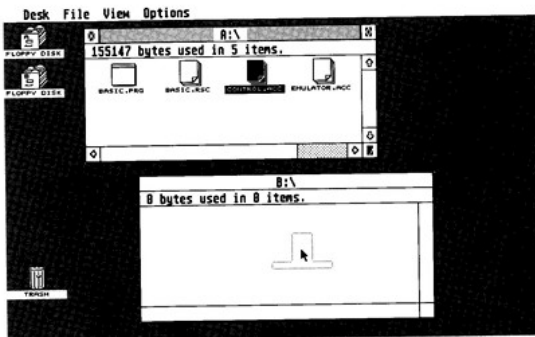

Another method is to drag a Floppy Disk icon to an open disk window; for instance, dragging Floppy Disk A's icon to Floppy Disk B's open window. This will copy the contents of Floppy Disk A to Floppy Disk B, but will leave Floppy Disk B's contents intact.

Both of these methods allow copying, provided there is room, from a double-sided disk to a single-sided disk and vice versa.

Dragging a Disk Icon to a Window

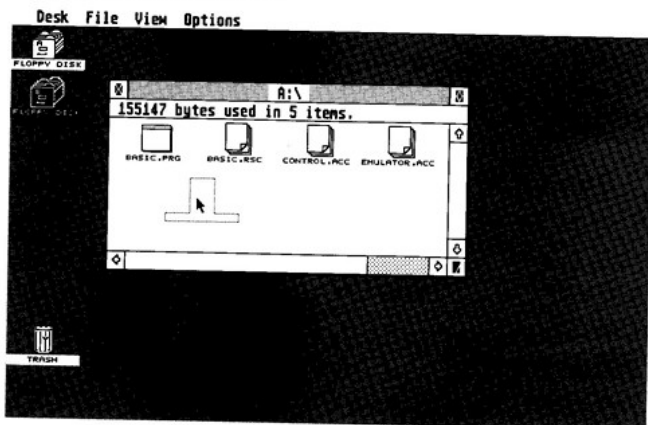

A third method of copying files is to drag a file into a folder. (For a description of that process, see **Folders** later in this chapter.)

Note: It's a good idea to make a backup copy of every file. If anything should happen to the original, you'll then always have a reserve copy on hand.

Multiple Selections

Sometimes you will want to select more than one icon. As you have seen, however, once you click on an icon, clicking anywhere else on the screen cancels your first selection.

There are two methods of selecting more than one icon. The first is to press and hold the left mouse button while the mouse pointer is to the left of the icons you want to select (nearby but not touching). Then drag the pointer down, to the right, and across the desired icons. As you drag the pointer, a rubber-band-like box will form around the icons, and every icon inside that box will be selected after you release the left mouse button. Once the items are selected, hold down the left mouse button while the pointer is on one item in the selected group. Now drag the entire group to where you want it.

Dragging the Pointer

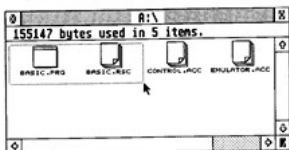

Selecting Items



Dragging the Items

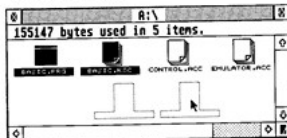

The second method for selecting more than one icon is to hold down the [Shift] key on the keyboard while you click on the icons. This is a convenient method when the items are not in sequence and cannot be separated from one another within the pointer's rubber-band box. Once the items are selected, hold down the left mouse button while the pointer is on one item in the selected group. As before, now drag the entire group to where you want it.

Note: Holding down [Shift] and clicking on icons actually switches between selected and unselected. That is, if selected, [Shift]-click will deselect the item; if unselected, then it will select the item. Sometimes you may find it convenient to combine the two methods of multiple selection: use the pointer's rubber-band box to select, then deselect the undesired items by [Shift]-clicking on them.



Deleting Files

To delete a file, select and drag the file to the Trash icon and follow the instructions on your screen. And remember: once you put something into the Trash, it's gone forever.

Renaming Files

To rename an existing file, select the file, point at the File heading on the Menu Bar, and select the Show Info option.

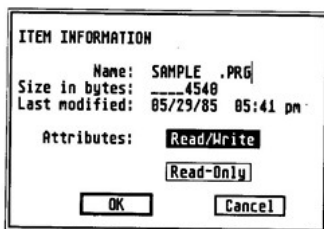

This sample Dialog Box shows the name and attributes of a file. You see a cursor (the vertical line) at the end of the filename. To change the filename, press [Backspace] or [Esc] on the ST Computer keyboard until you delete the old name and the cursor is at the beginning of the name block. Then type in the new name.

Note: Filenames can have a maximum of eight characters, optionally followed by a period (.) and a three-character extension.

Warning: Do not change the three-character extension for any of the files you received on your ST Language disk. If you do change an extension, you may prevent the system from using that file appropriately. (For more information on filenames and extensions, see **Show Info** and **Install Application** in Chapter 4.)

Folders

Folders are organized collections of files. They are neither programs nor data; you create folders as a means of organizing your files. If you have a window that contains numerous files, it can become difficult to distinguish any one item from the others. Because you may want to organize those files to make them readily accessible, the GEM Desktop allows you to create folders in which to store related files.

To create a folder, open a Floppy Disk icon, then point at the File heading on the Menu Bar and select the New Folder option. The following Dialog Box comes up on your screen:

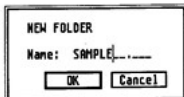

Type in a name for the folder and click on the OK button. If you change your mind about adding a folder, click on the Cancel button instead. Once you give the new folder a name and click on the OK button, the new folder pops into the currently active window.

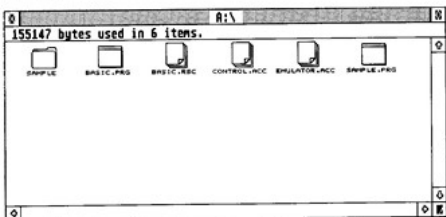

Note: Folders cannot be renamed.



To put a file into the folder, simply drag it to the folder. When the folder icon highlights, release the left mouse button, then follow the prompts in the Dialog Box and the file will be copied into the folder.

Dragging Files into a Folder

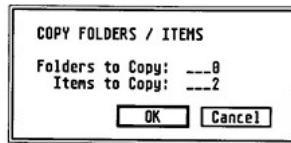
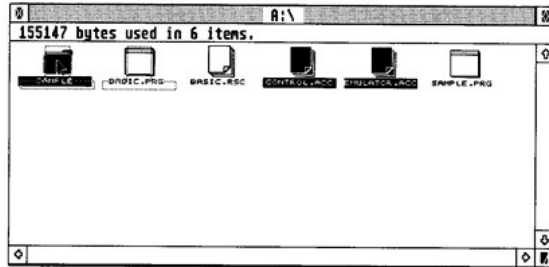

Once you create a folder, you can continue to copy files into it. You can even copy the entire contents of a disk to a folder. Simply drag the Floppy Disk icon to the folder and follow the prompts. This method of duplicating a disk works, provided there's room, when one disk is double-sided and the other disk is single-sided, and vice versa.

Note: Copying a file into a folder creates a new copy of the file and places it in the folder. After you place a copy of the file into a folder, you can delete the old file by dragging its icon onto the Trash icon.



Opening Folders

Every folder may be opened to its own window. If you open a Floppy Disk icon that contains a folder, the window won't immediately reveal the contents of the folder. You must open the folder into its window to view the items it contains.

To open a folder, either double-click on the folder's icon or select the folder (by single-clicking), then choose the Open option under the File heading.

Opening a Folder

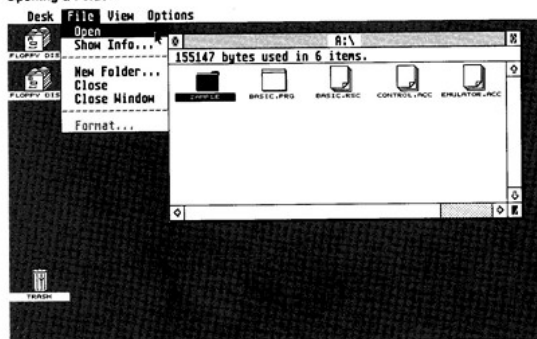

The folder actually opens in the former place of its parent disk's window. Once the folder is opened, its contents can be accessed.

Sample Open Folder

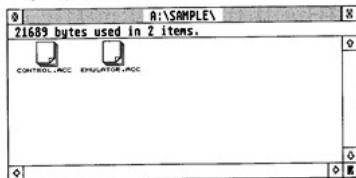



If you wish to open two folders at once (to copy data from one folder to another), open the Disk icon again, then select and open the next folder. Now the screen displays both folders' windows, and you can copy items from one folder to another.

Note: You can also create a folder within a folder, and can continue to do so down to eight levels.

Paths and Pathnames

Folders are actually directories within the main, or "root," directory of a disk in a disk drive (e.g., Drive A). A folder within a folder is a directory within a directory of the main disk directory. In order to keep all these directories straight, each has its own name. Pathnames designate main directories and folders.

Pathnames are of the form:

drive specification:\folder name\

where the drive specification specifies a root directory and the folder name specifies a folder. Each component of the pathname must be separated by a "backwards" slash (\). For example, the specification of the folder \LETTERS on floppy Drive A would appear as follows: A:\LETTERS\.

Folder in Main Directory

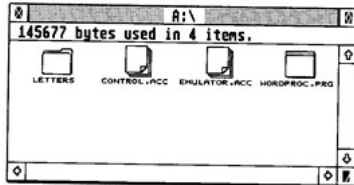

Open Folder

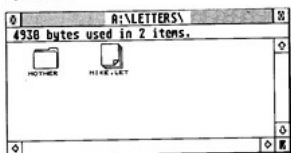

And the specification of the path created by placing the folder \MOTHER within \LETTERS on Drive A would appear as A:\LETTERS\MOTHER\.

Open Folder within a Folder



Prefixing a pathname to a filename tells the computer that you want to store or retrieve, for example, that file from the directory designated by the pathname. For example, suppose you have stored the letter MIKE.LET in the folder \LETTERS on Drive A. Suppose further that you've run your word processor from the main directory A:\. When running the word processor, you will not be able to access the file MIKE.LET unless you prefix the correct pathname to the filename, that is, A:\LETTERS\MIKE.LET.

Deleting Folders

When you want to delete a folder, drag it onto the Trash icon and follow the instructions on your screen. Keep in mind, however, that all files in the folder are deleted when the folder is deleted.



CHAPTER 4 THE MENU BAR

Along the top of the GEM Desktop is the Menu Bar. The menu headings are: Desk, File, View, and Options. To see the options within any menu, point at the menu heading. The heading highlights and the menu automatically drops down.

When you are ready to select a menu option, point at the option you wish to use and click the left mouse button once. The lightened words are options not available to you at the particular time you pull down the menu; they require that you first select or open a relevant file or disk.

Desk

The Desk heading contains the computer's Desk Accessories Menu. You may access the Desk Accessories in the menu at almost any time, provided you are using the GEM Desktop or another application that uses the GEM Menu Bar format. The standard set of Desk Accessories includes the VT™52 Emulator, Control Panel, Set RS232 Configuration, and Install Printer. However, particular GEM-compatible applications may contain Desk Accessories that differ slightly from the standard set.

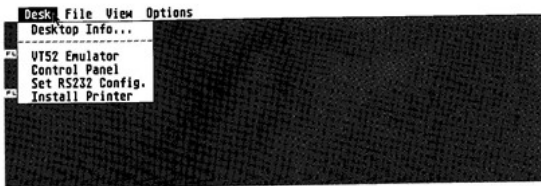

Note: Any changes you make to the standard Desk Accessories may be saved to disk. See the **Save Desktop** option later in this chapter.



Switching Your System On Without the Desktop Disk

If you switch on your computer without first inserting a disk with the CONTROL.ACC and EMULATOR.ACC files on it, the Desk Menu will contain only one item—Desktop Info.



Doing without the Desk Accessories does free up some of the computer's memory, but usually you'll want the Desk Accessories present. (For more information, see the section on **Slow Boot/ Fast Boot** in Appendix A.)

Desktop Info

The Desktop Info option is the billboard for the GEM Desktop, displaying the title of the desktop program in use and the program's copyright information. Most GEM Desktop-style programs will display this kind of identifying information when you select this option.

Point to and click on Desktop Info. You see the following Dialog Box:

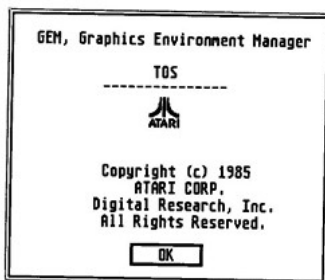

Click on the OK button to return to the GEM Desktop.



VT52 Emulator

The VT52 Emulator is an industry-standard telecommunications terminal program. When a modem is connected to your ST Computer, this program lets your computer communicate with other computers. Since the program is a bare terminal emulator only, it is most useful when used to hook into a large mainframe system.

Point to and click on the VT52 Emulator option from the Desk Menu. The VT52 Emulator immediately comes up on your screen.

```
*****
* Atari VT52 Terminal Emulator *
* (c) Atari Corp. *
*****
Press: 1) UNDO to return to desktop.
       2) HELP to configure terminal.
```

To configure the Modem port, press [Help] (see the instructions on the Set RS232 Configuration option later in this chapter). To return to the GEM Desktop, press [Undo].

Control Panel

This option allows you to alter a variety of system features. The Control Panel is a systemwide installation—the panel's settings affect the system as a whole. The Control Panel is divided into five sections: Clock/Calendar, Keyboard Response, Mouse Click Response, Audio Feedback, and Palette Control.

Point to and click on the Control Panel option in the Desk Menu. The Control Panel appears.

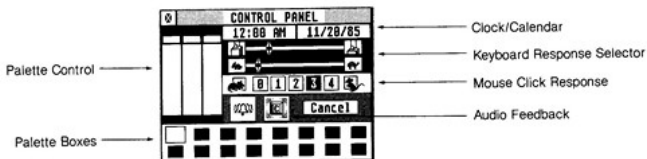



Once you've set the Control Panel parameters, click on the Close Box in the upper left-hand corner. To reset the panel to its previous setting, click on the Cancel button (or press [Return]).

Clock/Calendar

To set the clock or calendar, position the mouse pointer in the Clock window (left window) or the Calendar window (right window) and click the left mouse button. The window reverses shading to mark your selection. Use [Backspace] to position the cursor towards the beginning of the block (or [Esc] to erase the block), and enter the correct time or date directly from the ST Computer keyboard. When you finish, click in the Clock or Calendar window again (or press [Return]).

Once you set the time and date, the computer tracks the passage of time as long as it remains switched on. The system uses the Clock/Calendar to note the date and time individual files are created or revised (see the sections on **Show Info** and **Show as Text** later in this chapter). If you desire an accurate record of when your files are created or revised, you should reset the Clock/Calendar each time you switch on your computer.

Keyboard Response

Every key (except [Shift], [Control], and [Alternate]) on the ST Computer keyboard will repeat if you continue to hold it down. The Keyboard Response selector controls how soon the keys start repeating and how quickly they repeat.

The Upper Slide (Finger/Key icons) controls how soon the keys begin repeating once the key is held down: moving the slider to the left makes the keys repeat sooner. The Lower Slide (Rabbit and Turtle icons) controls the speed at which the keys repeat once they begin: moving the slider to the left makes the keys repeat faster. These two slides are particularly useful for adjusting the responsiveness of the cursor keys.

To set either slide, select then drag the slider to the desired position and release the left mouse button.

Mouse Click Response

If you do not double-click quickly enough, your computer may interpret the clicks as two separate single clicks. To slacken the computer's double-click response (allowing you to double-click more slowly), select one of the numbered boxes nearer to the Resting Mouse icon.



For experienced users, a slower double-click response may be inconvenient. To quicken the computer's double-click response (requiring you to double-click faster), select one of the numbered boxes nearer to the Running Mouse icon.

Audio Feedback

The ST Computer has two kinds of audio feedback: a click after each keystroke and a bell after keyboard and mouse movement errors. (A common mouse movement error occurs when you try to select another function before exiting a Dialog Box.) These sounds are emitted from your monitor's speaker. To activate or deactivate the computer's audio feedback, click on the Keytop icon or the Bell icon. An unshaded icon indicates that the function is active; a shaded icon indicates that it is disabled.

Palette Control

The Palette Control is fully functional only when you use either an ATARI Color Monitor or a color television (if applicable) as the computer's video display. However, with an ATARI High-Resolution Monochrome Monitor, the Palette Control does allow you to select either black text and graphics on a white background (default) or white text and graphics on a black background.

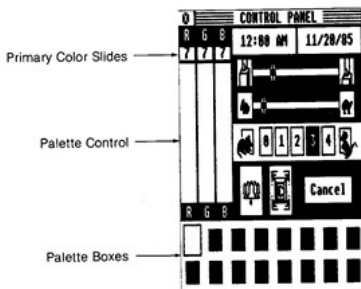



The Palette Boxes along the bottom of the Control Panel display "swatches" of color that you can modify. The Primary Color Slides allow you to mix the three primary video colors (Red, Green, and Blue) to make a palette of the colors you want. In low-resolution color display mode, the ST Computer can display up to 16 colors at one time from a palette of 512 colors (all 16 Palette Boxes are active). In medium-resolution color display mode, your ST Computer can display up to 4 colors at a time from a palette of 16 colors (the first two Palette Boxes in each row are active).

Click on one of the Palette Boxes along the bottom of the Control Panel. To modify the selected color, move any one of the three Primary Color Slides to the position you desire. You can move a slide by dragging it or by clicking on the "R," "G," or "B" along the top or bottom of each slide. Each slide has eight positions (0 through 7). Selecting a higher-numbered position increases the primary color's saturation-level relative to the selected palette color.

To invert the current monochrome display, set all sliders to position 0 or 7.

Set RS232 Configuration

The port labeled "Modem" on the back of the ST Computer is an RS232 serial port. By connecting a modem to your computer, you can communicate with other computers. You may also connect a serial printer, or any other RS232 device, to the Modem port.

When you select the Set RS232 Configuration option, the desktop displays the following Dialog Box:

RS232 PORT CONFIGURATION				
Baud Rate:	<input type="radio"/> 9600	<input type="radio"/> 4800	<input type="radio"/> 1200	<input type="radio"/> 300
Parity:	<input type="radio"/> None	<input type="radio"/> Odd	<input type="radio"/> Even	
Duplex:	<input type="radio"/> Full	<input type="radio"/> Half		
Bits/Char:	<input type="radio"/> 8	<input type="radio"/> 7	<input type="radio"/> 6	<input type="radio"/> 5
Strip Bit:	<input type="radio"/> On		<input type="radio"/> Off	
Flow Control				
Xon/Xoff:	<input type="radio"/> On		<input type="radio"/> Off	
Rts/Cts:	<input type="radio"/> On		<input type="radio"/> Off	
<input type="button" value="OK"/>		<input type="button" value="Cancel"/>		





The RS232 Configuration box lets you match the computer's RS232 port with the configuration of the modem (or serial printer) you are using. Refer to your modem manual for specific information on which parameters to choose. The major choices presented to you are explained below.

Baud Rate

Baud rate is the speed at which data is transmitted. (Baud, the standard unit measure of transmission speed, is measured in bits per second.) The fastest rate available to you is 9600 baud; the slowest is 300 baud. You must set the baud rate to accommodate both your modem and the remote computer's modem.

Parity

Whenever computers send information over the telephone lines, there is a chance that some of the information may get garbled, oftentimes due to imperfections and "noise" within telephone lines. Parity is a method that computers use to examine information and determine whether it has been cleanly transmitted. The parity bit is a binary digit added to a group of bits to make the total of all bits odd or even. Depending on your modem and the remote device, you will choose either ODD, EVEN, or NONE.

Duplex

Half Duplex configures the port for local echo; the characters you type are displayed on screen, then sent through the serial port. Full Duplex configures the port for host echo; the characters you type are sent directly out the serial port, then the host computer "echoes" them back to your computer. Most host computers now allow full-duplex transmission.

Bits/Char

Each character is stored in memory as one byte. A byte is made up of eight bits. Depending on the remote device, you may want to change the number of bits per character when transmitting through the RS232 port.

Strip Bit

This option determines whether the transmitted characters' eighth bit is "stripped" (i.e., set to zero). If your system works correctly with eight-bit characters, you'll normally not want the eighth bit stripped.



Xon/Xoff and Rts/Cts

These two choices represent flow control protocols. When transmitting through the RS232 port, your computer and the remote device must be able to tell one another when to start or stop sending information. Choose the flow control that the remote device supports.

Install Printer

This option lets you tell the computer which type of printer you have, as well as which features of the printer you wish the computer to activate when printing.

The Install Printer option is a systemwide installation that provides information to any utility or application. Whether or not a given program checks the Install Printer information before printing depends on the particular program itself. For example, the Print Screen option under the Options Menu on the GEM Desktop uses the Install Printer information, but other utilities or applications may not. Check the manuals that came with your programs to see if they make use of the Install Printer information.

Once you've set the Install Printer parameters, click on the OK button (or Cancel button to exit and void any option just set).

INSTALL PRINTER	
Printer Type:	<input checked="" type="radio"/> Dot <input type="radio"/> Daisy
Color:	<input checked="" type="radio"/> B/W <input type="radio"/> Color
Pixels/Line:	<input checked="" type="radio"/> 1200 <input type="radio"/> 960
Quality:	<input checked="" type="radio"/> Draft <input type="radio"/> Final
Printer Port:	<input checked="" type="radio"/> Printer <input type="radio"/> Modem
Paper Type:	<input checked="" type="radio"/> Feed <input type="radio"/> Single
<input type="button" value="OK"/> <input type="button" value="Cancel"/>	

Printer Type

Your choices are Dot (dot matrix printers) and Daisy (daisy wheel printers). Click on the appropriate box according to the type of printer you have.

Color

Your choices are B/W (black and white, that is, monochrome printers) and Color (color printers). Click on the appropriate box according to the type of printer you have.





Pixels/Line

This option is for use with dot matrix graphics printers only. Pixel means picture element. On dot matrix printers, a pixel is a dot. Dot matrix printers print a certain number of pixels (dots) per line when printing in graphics mode. If you have an ATARI Dot Matrix Graphics Printer, choose 1280. If you have an Epson, or Epson-compatible dot matrix graphics printer, choose 960. Both values, 1280 and 960, assume an eight-inch printed line.

Quality

For use with dot matrix printers only. Choose Draft for draft-quality printing. Choose Final for printing that is letter or near-letter quality (your printer must support near-letter-quality printing, of course).

When printing graphics, your printer will make one pass of the print head if set to Draft. For darker graphics, use Final (but keep in mind that the printer will make two passes of the print head, and so take twice as long to produce the graphic).

Printer Port

If you have a parallel printer, choose Printer. Parallel printers connect to the port marked "Printer" on the back panel of your computer. If you are using a serial printer, choose Modem. You should thus have your printer connected to the port marked "Modem" (the RS232 port) on the back of your computer.

Note: When using a serial printer, be certain you've configured the RS232 port for Xon/Xoff flow control. (See the section on Set RS232 Configuration earlier in this chapter.)

Paper Type

If your printer feeds paper automatically by means of a tractor or single-sheet feeder, choose Feed. If your printer accepts only a sheet at a time (which you must insert manually), choose Single. The Single option prevents the printer from printing beyond the end of a page should your text run longer than a single sheet.



File

The File Menu contains options that allow you to manipulate your files, manage your windows, create folders, and format disks.

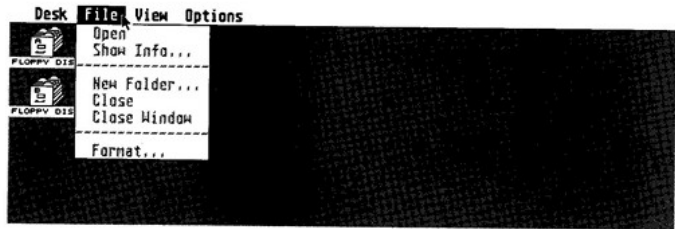

Open

The Open option is used to run a program or reveal the contents of a disk, file, or folder. To begin a program or open a file, select the file, point to the Open option in the File Menu, and click the left mouse button once.

An alternative to the Open option is to point to the file, then quickly double-click the left mouse button.

Show Info

When you select a file or desktop icon and then select the Show Info option, the screen displays information about the file or desktop icon you've selected. For example, the Show Info box for a Floppy Disk icon might look like the following:

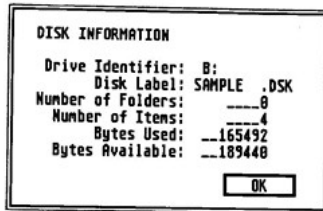

The Show Info box identifies the disk and gives the number of items stored and the number of bytes both used and available.

The Show Info box for a file might look like the following:

```
ITEM INFORMATION
Name: SAMPLE .PRG
Size in bytes: 4540
Last modified: 05/29/85 05:41 pm
Attributes: Read/Write
           Read-Only
           OK      Cancel
```

The Show Info box for a file identifies the item and gives the size, date last modified, and its read/write attributes. The Read/Write and Read-Only options allow you to alter a file's read/write attributes. Choose Read/Write if you want to be able to modify ("write to") the file; choose Read-Only if you want the computer to only "read" but not "write to" the file. The Read-Only option protects valuable files from accidental modification.

You can rename the file within the Show Info box. Press [Backspace] or [Esc] to delete the filename, type a new name, and either press [Return] or click on the OK button to write the new filename on the disk.

Note: Depending on the number and size of your files, the number of bytes used plus the number of bytes available may not equal the exact storage capacity of the disk. This is because the ST Computer reserves at least 1024 bytes on the disk for each file, even if the file is smaller. You should use Show Info's Bytes Available information to monitor your available disk storage space.

New Folder

Folders are organized collections of files. They are neither programs nor data; you create folders as a means of organizing your files. If you have a window that contains numerous files, it can become difficult to distinguish any one item from the others. Because you may want to organize those files to make them readily accessible, the GEM Desktop allows you to create folders in which to store related files.



When you use this option to create a folder, the following Dialog Box appears on your screen:

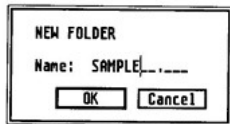

Refer to **Folders in Chapter 3** for a complete description of using folders.

Close and Close Window

There are three ways to close a window. If you have a window on your screen and you don't want it displayed, you can either select the **Close** or **Close Window** options from the **File Menu**, or you can click on the window's **Close Box**.

It's always a good idea to close windows if you are not using them. Since you can have four windows open on the **GEM Desktop** at any one time, any extra open windows only serve to use up available desktop space.

Both the **Close** and **Close Window** options shut down only the currently active window, not all the windows on the **GEM Desktop**. But there is a difference between the two: if a given folder's window is active, the **Close** option (or **Close Box**) will close it down and return you to the folder's **Floppy Disk** window; however, **Close Window** will at once close down both the folder's window and the **Floppy Disk**'s.

Format

In **Chapter 2** you were shown how to format a disk. This section will not take you step-by-step through the process again. Instead, it will review a few important points about disks and formatting them for use.

The surface of a floppy disk is similar to the surface of a record. As with a record, the information that you store on disk is recorded in circular patterns. However, unlike record patterns, disk patterns are not in place when you first buy the disk; you must put them onto the disk before you can use it. Furthermore, a record is mechanically recorded, whereas a disk is magnetically recorded (more like audio tape). The process of preparing a disk to accept data is called "formatting." To format a disk, select the **Floppy Disk** icon to be formatted, then select the **Format** option from the **File Menu**.



The only chance to label a disk comes in the Format box. (You cannot rename a disk using Show Info; you must reformat it.) Type in the name using the ST Computer keyboard. Use the [Backspace] key to delete any errors. Click on the OK button and the disk will be formatted (and named). A Format Working box monitors the formatting process.

When the process is complete, a Dialog Box displays the number of bytes available for storage on the disk. If your disk doesn't show 357,376 (single-sided) or 726,016 (double-sided) bytes available, the disk may be defective. Try formatting again. If the problem persists, place a new disk in the disk drive and format it.

Warning: You can reformat old disks, but if you do, any data that was on the disks will be lost— forever. Copy the files you want to save before reformatting the disk.

View

The View Menu allows you to control whether your files will be displayed as Icons or Text, as well as whether they will be sorted (ordered) by Name, Date, Size, or File type.

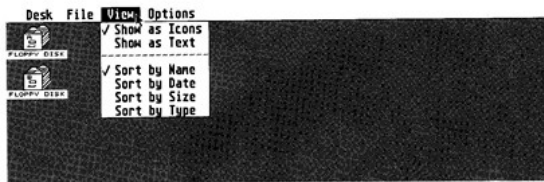

Note: Any changes you make using the View Menu can be saved to disk. Refer to the **Save Desktop** section for instructions.



Show as Icons and Show as Text

The check mark in front of the menu item indicates how you will view the file display. To modify how files are displayed, select the option you want by clicking on it. The following two windows show a file display as Icons and as Text for the same disk.

Shown as Icons

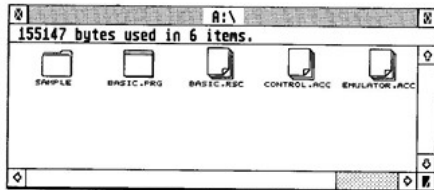

Shown as Text

A screenshot of a file window titled "A:\\" showing "155147 bytes used in 6 items." The files are displayed as text with columns for filename, extension, size, date, and time. A small box icon next to "SAMPLE" indicates it is a folder.

Filename	Extension	Size	Date	Time
<input checked="" type="checkbox"/> SAMPLE			11-20-85	12:04 am
BASIC	PRG	123988	05-29-85	05:34 pm
BASIC	RSC	4938	05-29-85	05:34 pm
CONTROL	ACC	15238	11-20-85	12:00 am
EMULATOR	ACC	6451	11-20-85	12:01 am
SAMPLE	PRG	4540	11-20-85	12:01 am

When a file is displayed as text, the window shows the filename and size, as well as the date and time the file was last modified. A small box icon next to a filename in the text-displayed window indicates that the file is a folder, not an application or data file.

Sort by Name, Date, Size, and Type

When you open a disk or folder's window, the computer orders the items on screen according to the criterion set with this menu. When Sort by Name is set, files are listed in alphabetical order. Sort by Date lists the files chronologically, with the most recently created or revised file appearing first. When Sort by Size is set, files are listed according to the number of bytes per file, with the largest file appearing first. Sort by Type orders files alphabetically according to their extensions, grouping files with common extensions together.



The screen below shows two windows for the same disk, but one window's files are ordered by Name and the other's by Date.

Sorted by Name

A:\					
155147 bytes used in 6 items.					
X	SAMPLE			11-20-85	12:04 am
	BASIC	PRG	123988	05-29-85	05:14 pm
	BASIC	RSC	4938	05-29-85	05:14 pm
	CONTROL	ACC	15238	11-20-85	12:00 am
	EMULATOR	ACC	6451	11-20-85	12:01 am
	SAMPLE	PRG	4540	11-20-85	12:01 am

Sorted by Date

A:\					
155147 bytes used in 6 items.					
X	SAMPLE			11-20-85	12:04 am
	SAMPLE	PRG	4540	11-20-85	12:01 am
	EMULATOR	ACC	6451	11-20-85	12:01 am
	CONTROL	ACC	15238	11-20-85	12:00 am
	BASIC	PRG	123988	05-29-85	05:14 pm
	BASIC	RSC	4938	05-29-85	05:14 pm

Options

The Options Menu includes a variety of useful desktop features.

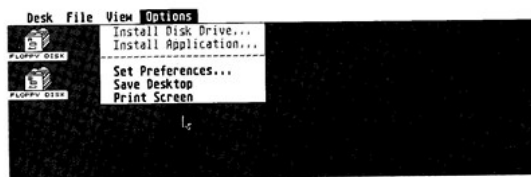

Note: Any changes you make with the Options Menu can be saved to disk. (See the Save Desktop section later in this chapter.)



Install Disk Drive

When you switch on your ST Computer, the GEM Desktop displays two Floppy Disk icons. Each disk has a disk identifier (a letter) and an icon label. You can change the label, remove a disk icon, or re-install a disk icon with the Install Disk Drive option.

Select a Floppy Disk icon, then select the Install Disk Drive option. The following Dialog Box will be displayed:



To install a new disk icon, select a disk icon, choose Install Disk Drive, then type in the disk identifier (any letter) of the icon you wish to install ("c" stands for Cartridge; "C" for Hard Disk). You may have only two disk icons (A and B) representing your floppy disk drives.

To change the disk label, point at the current name and click the left mouse button; press [Backspace] on the ST Computer keyboard to erase the current name; then type in any name you wish. Click on the Install button.

To remove a disk icon, select the icon, choose Install Disk Drive, then click on the Remove button.

To re-install a disk icon you've removed, select the remaining icon, choose Install Disk Drive, then type in the disk identifier of the missing disk. Click on the Install button.

Warning: Use the Install Disk Drive option with caution. If you remove both disk icons and then save this modified desktop to your Desktop disk, you'll need to make a new Desktop disk to get the disk icons functioning again.

Install Application

With the Install Application option, you can determine the kind of data file that will open an application.



With an applications program selected in a window, select the Install Application option from the Options Menu. The following Dialog Box will be displayed:

INSTALL APPLICATION

Application Name: WORDPROC.PRG
Document Type: _____
Application Type:

GEM TOS TOS-takes parameters

There are two methods of installing an application. The first method is to tell the computer that you'd like files with a particular filename extension (the three letters that follow the period in a filename), once opened, to automatically run the application program you've installed. For example, suppose you are using a word processor and have word-processed files named with the .DOC ("document") extension. You can install the word processor to run from this extension. Type DOC after the Document Type option in the Install Application box. You can now open any file with the .DOC extension and the word processor will run automatically, simultaneously loading the file opened. The program file, however, must be in the same directory as the data file.

Choose "GEM" if you have an application that takes advantage of the special windowing features of GEM. Choose "TOS" if the application is not a GEM-compatible program. Click on the OK button.

The second method of installing an application is to use the "TOS-takes parameters" option, provided, again, that your program does not use the features of GEM. In this case, you do not need to specify a filename extension. You simply install the application with "TOS—takes parameters," then click on the OK button. When you open the installed application, you see the following Dialog Box:

OPEN APPLICATION

Name: SAMPLE .TTP
Parameters: _____



Type in the filename(s) or other parameters the program expects. Click on the OK button. The applications program loads and uses the parameters supplied.

Note: The three ways to install an application may be explicit in a given application's filename extension. For instance, .PRG files denote GEM-compatible programs; .TOS denotes non-GEM applications; and .TTP denotes non-GEM, parameter-taking applications. A .TTP file need not be installed. The Open Applications box will appear automatically when you run any .TTP file.

Set Preferences

The Set Preferences option lets you determine how the ST Computer interacts with you through the prompts and Dialog Boxes, and what resolution your monitor display will be in.

When you select the Set Preferences option, the following Dialog Box is displayed:

SET PREFERENCES

Confirm Deletes:

Confirm Copies:

Set Screen Resolution:

Confirm Deletes and Confirm Copies

These two options determine whether the ST Computer waits for confirmation before deleting a file or making a copy. You can set up the Alert Message system to suit your own needs.

Select Screen Resolution

These parameters provide one of three video screen resolutions: Low, Medium, or High. With the ATARI High-Resolution Monochrome Monitor, you can select only High Resolution. With the ATARI RGB Color Monitor, you can select either Medium or Low Resolution. For best results with a television, you should select Low Resolution.

Warning: If you change screen resolution without a Desktop Disk in Drive A, the Desk Accessories will be erased from memory.





Save Desktop

To save any modification you make to the GEM Desktop, use the Save Desktop option. This is an extremely valuable feature—you can save the desktop format you prefer and have it come up every time you switch on your computer.

Insert your Desktop disk (a disk that contains the CONTROL.ACC and EMULATOR.ACC files) in your drive and click on the Save Desktop option. The computer writes a file called DESKTOP.INF to the disk. Each time you switch on your computer with that disk inserted, the system checks the DESKTOP.INF file and runs the desktop as you have modified it. The size and location of windows and any changes you have made using the Desk, View, or Options Menus are saved to the DESKTOP.INF file.

Print Screen

This option prints the current screen display; it prints everything displayed, including the mouse pointer. You must have a graphics printer connected to your computer to use the Print Screen utility. Make sure the printer is switched on and that it has been installed (see the section on **Install Printer** earlier in this chapter). Then click on Print Screen to activate the function. Press **[Alternate] [Help]** to stop printing midway, if necessary.

You can also activate the Print Screen utility by pressing **[Alternate] [Help]**. Press **[Alternate] [Help]** again to stop printing midway, if necessary.

Note: If you select the Print Screen utility without first switching on your printer, the system will time-out in approximately 30 seconds.





CHAPTER 5

APPLICATIONS FOR YOUR ST COMPUTER

Any computer must be programmed in order to run; otherwise, it's simply a box with some microchips—to be sure, a box filled with much potential. When you first switch on your computer, the GEM Desktop comes up on your screen only because TOS (The Operating System), which includes the desktop program, has been permanently encoded into one part of the computer's memory. Permanently encoding the chips inside a computer is one way to make a computer run a program. These encoded chips make up your computer's ROM (Read Only Memory) and are programmed at the factory.

The most common way of running programs—the way you, as a user, will run programs—is to load them from disk into your computer's memory. These sorts of programs are called applications (the computer is “applied” to a certain task). The world of applications programs runs the gamut from word processing to graphics programs, and from spreadsheet and database management to game programs.

Programming languages, on the other hand, allow you to run programs that you have written (or have entered into the computer) using the programming language itself.

The special features and power of the ST Computer are being used to full advantage in hundreds of new applications programs and programming languages.

Programming Languages

ST BASIC

The ST Language disk that came with your computer contains the programming language ST BASIC. ST BASIC is contained in the program file BASIC.PRG. The data file BASIC.RSC is required to run the language.

BASIC was originally designed as an easy-to-learn, yet powerful programming language. Today, it remains the most commonly used programming language among microcomputer users. ST BASIC resembles the mainstream dialects of BASIC (as all BASICs do), yet takes advantage of the unique features of the ST Computer.





ST BASIC contains a full complement of string manipulation functions, advanced math features, and print formatting commands. The ST BASIC editor uses the windows and drop-down menus of the GEM Desktop to full advantage, featuring windows for both text and graphics.

For detailed information on ST BASIC, refer to the manual, ST BASIC Sourcebook and Tutorial.

Note: Always use your backup copy of the ST Language disk when working with ST BASIC.

ST LOGO™

LOGO is a unique and enchanting programming language, best known for its use with students who are beginning programmers. LOGO works with "turtle graphics," a special system where an imaginary turtle draws lines and shapes under the program's control. Unlike other programming languages, you can learn programming through graphics without any understanding of higher math.

ST LOGO is an expanded version of the original language. As such, it takes advantage of the mouse, the drop-down menus and the windows of the GEM Desktop, the speed of the 68000 microprocessor, and incorporates an array of new LOGO commands not found in any other version of the language. All in all, ST LOGO represents a new advance in the LOGO programming language, specially created to take advantage of the versatility and power of the ST Computer.

Commercial Applications Programs

Many commercial applications programs that run on your ST Computer are currently available. Others are under development at both Atari Corporation and a host of independent software developers. Look for these new and exciting products at your ATARI Computer retailer.

Word Processors

Word processing is easily one of the most valuable tasks your ST Computer can help you tackle. Word-processing programs transform your computer into a super typewriter, and allow you to use your computer to write personal letters, term papers, business reports, form letters, and the like.

Note: ST Logo is available from your ATARI ST Computer retailer.





With a word processor, you compose text using your computer keyboard just as you would on a conventional typewriter. The difference is that the computer records the characters you type electronically, so you can correct your mistakes and make any changes you want before printing your work on paper. You can delete words, phrases, or whole chunks of text; you can insert new words or phrases, or move blocks of text from place to place within your text—all with only a few keystrokes or mouse clicks.

In short, word processors afford you the opportunity to experiment and arrange your written work on screen using virtually any text format—then you can send your work directly to an ATARI ST Printer. You can store your work on disk for later reference or revision.

Spreadsheet and Database Programs

Spreadsheet programs allow you to manipulate on screen an entire worksheet of numbers and formulas, which you can design in various ways: to analyze the stock market, figure your income tax, or calculate your business profit.

Database programs allow you to compile, store, and retrieve large pools of information. You can then use the program to search the database for a particular piece of information, for all information meeting some specified criterion, or sort the information you have stored in a particular way.

Business graphics programs enable you to display and print pie charts and line and bar graphs according to the values you supply.

Entertainment Programs

The ST Computer's superb graphics and high-speed animation capabilities combine with the latest in ST game programs to deliver arcade-quality entertainment action. Recreational graphics programs, like the paint program NEOchrome™ from Atari Corporation, allow you to turn your computer into an artist's canvas and exploit the color graphics power of the ST Computer.



Telecommunications Software

You can turn your computer into a telecomputing terminal with ST telecommunications software and an ATARI ST Modem. Once you're "on-line," you'll be able to peruse the hundreds of electronic bulletin boards and subscription information, banking, and shopping services across the country—all the while never leaving your home or office.

Educational Programs

Children and adults alike will benefit from the expanding library of educational programs for the ATARI ST Computer. You'll enjoy self-paced, self-study in math, science, and language arts.

MIDI Software

The ST Computer's built-in, industry-standard Musical Instrument Digital Interface (MIDI) puts you in control of the newest generation of electronic instruments and state-of-the-art sound studio equipment.





APPENDIX A TROUBLESHOOTING AND PREVENTIVE MAINTENANCE

Troubleshooting

If you run into problems while hooking up or operating your ST Computer, chances are the difficulty is a minor hitch that you can take care of yourself. This section describes some possible problems and suggests simple solutions.

It Just Won't Work

Probably the most common problem is that sometimes the machine just won't work—it just doesn't respond. Usually the remedy is a very simple matter.

If your computer just won't budge (for instance, the screen stays dark), take the following steps:

1. Switch off all parts of your ST Computer system. Now make sure all connections are correct and secure. Check to see that the power cables are connected properly, and that the video cable is plugged in firmly to both the computer and monitor.
2. Switch all components on. Be certain that the computer's front panel power light, the drive's busy light, and the monitor's power light all come on.
3. Check to be sure that the brightness and contrast adjustments on your monitor are turned up. If the display is still not proper, your computer or monitor may need service.

Software Problems

If you are still having difficulty getting the system up and running consistently, it may be that the software application you are using has a few imperfections or that the disk contains garbled data. Try switching your computer off for a few seconds, then on again. If this helps, it may be that the application experienced a momentary failure, probably due to imperfections in the program itself. If switching the computer off and on doesn't help, try switching on the system using another disk. If this works, the problem is probably with the first disk. But if none of your disks work well, your computer or drive may need repair.



Slow Boot/Fast Boot

If you don't have a disk inserted in the drive when you first switch on the computer, the GEM Desktop takes much longer to appear (about 40 seconds). Once it does appear, you won't have any Desk Accessories available under the Desk Menu. The fastest boot is with a disk that does not have the CONTROL.ACC and EMULATOR.ACC files (Desk Accessories) on it. However, again, you won't be able to access any of the Desk Accessories.

The Mouse

You may eventually have problems controlling the mouse pointer: it may move slowly or sporadically. To solve the problem, first make sure the mouse is plugged firmly into Mouse/Joystick port 0. If the problem persists, see the section on **Caring for Your Mouse** later in this chapter.

The Keyboard

Don't be concerned that typing on the keyboard produces nothing on screen from the desktop. The GEM Desktop is not an application that permits typing from the keyboard in most instances. When using the desktop, however, you should be able to control the mouse pointer with the cursor keys (see **Controlling the Mouse Pointer with the Cursor Keys** in Chapter 2). When you name files or disks, the desktop will of course permit you to type from the keyboard.

A Final Note

Your ATARI ST Computer system is designed for low maintenance and high reliability. Like anything electronic and mechanical, however, a computer system can break down. If you experience problems that you think may be serious, the best course is to take your computer to your ATARI retailer.





Preventive Maintenance

To ensure top performance from your ST Computer system, follow the simple guidelines below:

Caring for Your ST Computer System

- Avoid dusty or greasy work areas.
- Avoid smoking near your computer system.
- Keep all components away from extreme heat or moisture.
- Keep liquids away from the components.
- Clean the outside of the components with a soft, lint-free cloth only. Do not use cleansers, abrasives, or solvents, which may damage the components' plastic housings.
- Keep all components out of direct sunlight.
- Always have your system securely placed on a firm, level surface.
- Do not move the components more than necessary.
- When you switch off the computer, wait at least two seconds before you switch it on again.
- To ship or store your system, repack it in the original factory packing materials.

Caring for Your Microfloppy Disks

- Do not switch the disk drive off while it is busy. Do not leave disks in the drive when the drive is off.
- Keep disks away from sources of magnetism (monitor, television, electric motor, or telephone).
- Keep disks away from extreme heat or moisture.
- Never leave disks in direct sunlight.
- Never touch or clean a disk's recording surface inside the plastic housing.

Caring for Your Mouse

Your ST Computer Mouse will last through many years of use if you treat it properly. Two general guidelines for proper mouse care are:

- Don't drop the mouse or allow it to "hang by its tail."
- Make sure the surface on which you use the mouse is as smooth and clean as possible.





APPENDIX B CONNECTOR PINOUT SPECIFICATIONS



Modem

- 1 — Protective Ground
- 2 — Transmitted Data
- 3 — Received Data
- 4 — Request to Send
- 5 — Clear to Send
- 6 — Not Connected
- 7 — Signal Ground
- 8 — Data Carrier Repeat
- 9-19 — Not Connected

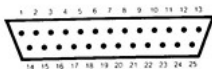

- 20 — Data Terminal Ready
- 21 — Not Connected
- 22 — Ring Indicator
- 23-25 — Not Connected



Printer

- 1 — Centronics® STROBE
- 2 — Data 0
- 3 — Data 1
- 4 — Data 2
- 5 — Data 3
- 6 — Data 4
- 7 — Data 5
- 8 — Data 6
- 9 — Data 7

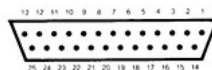

- 10 — Not Connected
- 11 — Centronics BUSY
- 12-17 — Not Connected
- 18-25 — Ground



Hard Disk

- 1 — Data 0
- 2 — Data 1
- 3 — Data 2
- 4 — Data 3
- 5 — Data 4
- 6 — Data 5
- 7 — Data 6
- 8 — Data 7
- 9 — Chip Select
- 10 — Interrupt Request
- 11 — Ground
- 12 — Reset

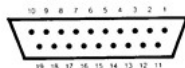

- 13 — Ground
- 14 — Acknowledge
- 15 — Ground
- 16 — A1
- 17 — Ground
- 18 — Read/Write
- 19 — Data Request

Note: All pinout diagrams are from the external port view.



Floppy Disk

- 1 — Read Data
- 2 — Side 0 Select
- 3 — Logic Ground
- 4 — Index Pulse
- 5 — Drive 0 Select
- 6 — Drive 1 Select
- 7 — Logic Ground
- 8 — Motor On
- 9 — Direction In
- 10 — Step

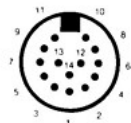

- 11 — Write Data
- 12 — Write Gate
- 13 — Track 00
- 14 — Write Protect



Television (where applicable)

- Core — RF Modulated Video
Shield — Ground

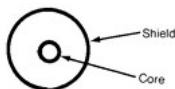

Monitor

- 1 — Audio Out
- 2 — Composite Video
(where applicable)
- 3 — General Purpose Output
- 4 — Monochrome Detect
- 5 — Audio In
- 6 — Green
- 7 — Red
- 8 — Plus 12-Volt Pullup
- 9 — Horizontal Sync

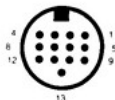

- 10 — Blue
- 11 — Monochrome
- 12 — Vertical Sync
- 13 — Ground



Midi Out

- 1 — THRU Transmit Data
- 2 — Shield Ground
- 3 — THRU Loop Return
- 4 — OUT Transmit Data
- 5 — OUT Loop Return

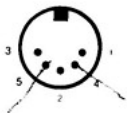



Midi In

- 1 — Not Connected
- 2 — Not Connected
- 3 — Not Connected
- 4 — IN Receive Data
- 5 — IN Loop Return

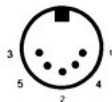

Cartridge

- 1 — + 5 VDC
- 2 — + 5 VDC
- 3 — Data 14
- 4 — Data 15
- 5 — Data 12
- 6 — Data 13
- 7 — Data 10
- 8 — Data 11
- 9 — Data 8
- 10 — Data 9
- 11 — Data 6
- 12 — Data 7
- 13 — Data 4
- 14 — Data 5
- 15 — Data 2
- 16 — Data 3
- 17 — Data 0
- 18 — Data 1
- 19 — Address 13
- 20 — Address 15
- 21 — Address 8
- 22 — Address 14

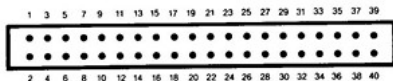

- 23 — Address 7
- 24 — Address 9
- 25 — Address 6
- 26 — Address 10
- 27 — Address 5
- 28 — Address 12
- 29 — Address 11
- 30 — Address 4
- 31 — ROM Select 3
- 32 — Address 3
- 33 — ROM Select 4
- 34 — Address 2
- 35 — Upper Data Strobe
- 36 — Address 1
- 37 — Lower Data Strobe
- 38-40 — Ground





Mouse / Joystick

- 1 — Up/XB
- 2 — Down/XA
- 3 — Left/YA
- 4 — Right/YB
- 5 — Not Connected
- 6 — Fire/Left Button
- 7 — + 5VDC
- 8 — Ground
- 9 — Joy1 Fire/Right Button

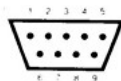

Joystick

- 1 — Up
- 2 — Down
- 3 — Left
- 4 — Right
- 5 — Reserved
- 6 — Fire Button
- 7 — + 5VDC
- 8 — Ground
- 9 — Not Connected

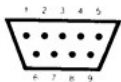

APPENDIX C ST COMPUTER SPECIFICATIONS

Computer

Processor	MC68000, 32-bit internal, 16-bit external architecture; 8 MHz clock frequency
Memory:	
4160ST	4,194,304 bytes of RAM; 196,608 bytes of ROM
2080ST	2,097,152 bytes of RAM; 196,608 bytes of ROM
1040ST	1,048,576 bytes of RAM; 196,608 bytes of ROM
520ST	524,288 bytes of RAM; 196,608 bytes of ROM
Graphics Resolution (selectable)	640 x 400 monochrome 320 x 200 x 16 colors 640 x 200 x 4 colors
Color	Palette of 512 colors
Interfaces	RS232 Serial Modem Port Parallel Interface Printer Port Hard Disk Port (10 megabits per second DMA transfer rate) Floppy Disk Port (includes controller) TV Port (not included on some models) Monitor Port (RGB Analog; high-resolution monochrome, composite video, and audio) Midi In and Midi Out Ports ROM Cartridge Port (128 kilobytes capacity) Mouse/Joystick and Joystick Ports
Sound Generator	3 voices from 30 Hz to above audible range
Keyboard	94-key intelligent keyboard using 6301 microprocessor
Power Supply (built-in)	+5V @ 3A +12V @ 1A -12V @ 30mA
Power Consumption	95 Watts (maximum)
Ambient Temperature	41 to 113 °F (5 to 45 °C), operating or idle -4 to 149 °F (-20 to 65 °C), storage -40 to 149 °F (-40 to 65 °C), transport
Relative Humidity (noncondensing)	20 to 80 %, operating or idle up to 95 %, storage or transport



Disk Drive

Track Density	135 tracks per inch
Storage Capacity:	
4160ST, 2080ST, 1040ST	720 kilobytes total per disk (formatted MFM)
520ST	360 kilobytes total per disk (formatted MFM)
Storage Medium:	
4160ST, 2080ST, 1040ST	3 1/2-inch microfloppy disks; double-sided, double-density; 135 tracks per inch
520ST	3 1/2-inch microfloppy disks; single-sided, double-density; 135 tracks per inch
Head Positioning Mechanism	Stepper motor
Data Transfer Speed	250 kilobits per second
Physical Characteristics	
4160ST, 2080ST, 1040ST	Maximum height 2 3/4" Width 18 3/4" Depth 11 1/2" Weight 9 lb. 7 oz. Internal power supply
520ST	Maximum height 2 1/2" Width 18 3/4" Depth 9 1/2" Weight 4 lb. 6 oz. Internal power supply





GLOSSARY

Alert Messages Alert Messages inform you that the operation you want to perform is potentially dangerous, improper, or impossible. Alert Messages are always displayed in a Dialog Box.

BASIC Beginner's All-Purpose Symbolic Instruction Code. The programming language contained on the ST Language disk.

Baud Rate The speed at which characters are transmitted from one source to another. You can transmit information from your computer through a modem over the telephone lines to another computer. Baud is the standard unit measure of transmission speed calculated in bits per second.

Bee icon Whenever the computer transfers or retrieves information from the disk drive, the screen displays the Bee icon.

Bit The smallest unit of computer memory. Eight bits equal one byte of memory. (See **Byte**.)

Boot To switch on your system. Pressing the Reset button on the back panel of the computer "reboots" the system.

Byte Computer memory is arranged into units of bytes. Each byte consists of eight bits, and is a unique character within the computer (e.g., the letter "a" is stored as one byte in memory). (See **Bit** and **Kilobyte**.)

Cartridge One of four means of entering data and programs into the ST Computer. The other means are: a disk drive, the keyboard, and an external port (e.g., the Modem port). Cartridges connect to the computer's left side panel.

Click To point the mouse pointer at a word or icon on the screen, press the mouse button, then quickly release it.

Close Box The small box at the upper left-hand corner of a window, used to close an active window.

Color Palette A function of the Control Panel that allows you to modify the colors available on the ST Computer. You must use the ATARI RGB Analog Color Monitor, a composite monitor, or a color television for the Color Palette to function fully.

Control Panel A Dialog Box that allows you to control many of the GEM Desktop functions. The Color Palette, Mouse Click Response, Keyboard Response, Clock/Calendar, and Audio Feedback are adjusted with the Control Panel.

Cursor A marker that appears on the screen to indicate the position of the next typed character.

Data File A collection of information used by a program. Data files are not programs. Data file icons look like sheets of paper with one folded corner.



Desk Accessory A menu option under the Desk heading that can be accessed at most times, either directly from the GEM Desktop or while using some other application.

Desktop Disk Among other things, the ST Language disk contains the data your computer needs to provide a full complement of Desk Accessories. Put a copy of the CONTROL.ACC and EMULATOR.ACC files on another disk. Call this your "Desktop" disk. Use it (or another with those files) when you boot the system.

Dialog Box Dialog Boxes are interactive message boxes. To exit a Dialog Box, you must acknowledge the message or choose an option.

Diskcopy A program that makes an exact copy of all of the data on a disk. To make a disk copy, drag the icon of the source disk on top of the icon for the destination disk. The Diskcopy procedure erases all information from the destination disk.

Disk Drive The primary storage device for your ST Computer. The computer uses the disk drive to read information from or write information to a floppy disk. Disk drives are represented by a Floppy Disk icon on the GEM Desktop.

Double-click Two quick clicks on the left mouse button. A double-click opens a file, disk, or folder.

Dragging The technique for moving an item on the desktop, such as an icon, file, or window. Point at the item with the mouse pointer, press the left mouse button, and hold the button down while moving the mouse. While the icon is being dragged, a ghost image of the item you are moving appears on the desktop.

File A collection of information that has been stored or can be stored on a disk or in the computer's memory.

File Copy To copy single files from one disk to another, drag the icons that represent the files you want to copy over to and on top of the new disk's icon. You can also drag files between the opened windows of two disks.

Floppy Disk The medium used to store information. The disk is made of a material similar to audio tape.

Folder A collection of files. Folders provide a way to organize your files on disk. To access a file that has been placed in a folder, double-click on the folder. A folder opens up into its parent window. Folder icons look like file folders.

Format Information is stored on your floppy disks in circular patterns. When you format a disk, you set the patterns so information can then be stored on the disk. Formatting erases all information previously stored on the disk.

Full Box Used to change the size of a window alternately from normal to full-screen.





GEM Graphics Environment Manager. A program used in TOS that creates and manages all the window icons, menus, and graphics features of the ST Computer.

GEM Desktop The main screen for the ST Computer. It includes the Menu Bar, two Floppy Disk icons, and the Trash icon.

Ghost An outline of an icon, filename, or window used to show the current position of the item as it is dragged to a new location on the desktop.

Hard Disk A device used to store data on a magnetic surface. The disk itself is permanent (not removable). A hard disk drive can store far more data than a floppy disk drive, and can read and write information many times faster.

High-Resolution One of three video display modes available with the ST Computer. In high-resolution mode, the ST Computer's display consists of 640 dots horizontally by 400 dots vertically. In order to use the high-resolution mode, you must have an ATARI High-Resolution Monochrome Monitor. (See **Low-Resolution** and **Medium-Resolution**.)

Icon A picture on the desktop that may represent disks, files, folders, or procedures.

Information Line The line at the top of an active window telling how many bytes are used and in how many items (files).

Input/Output (I/O) The communication process that takes place between the ST Computer and its peripheral devices (i.e., disk drives, printers). Input is information that is sent "in" to the computer; output is information the computer sends "out."

Interface An electronic connection that allows communication between the computer and its peripherals.

Kilobyte (K) 1024 bytes. (See **Bit** and **Byte**.)

LOGO A powerful graphics programming language available for your ST Computer.

Low-Resolution One of three video display modes available with the ST Computer. In low-resolution mode, the ST Computer's display consists of 320 dots horizontally by 200 dots vertically. In this mode, the computer can display up to 16 colors at a time from the total palette of 512 colors. (See **High-Resolution** and **Medium-Resolution**.)

Medium-Resolution One of three video display modes available with the ST Computer. In medium-resolution mode, the ST Computer's display consists of 640 dots horizontally by 200 dots vertically. In this mode, the computer can display up to four colors at a time from the total palette of 512 colors. (See **High-Resolution** and **Low-Resolution**.)



Memory The electronic circuits that the ST Computer uses to store data and programs. There are two kinds of memory: RAM (Random Access Memory) and ROM (Read Only Memory). RAM loses its data if the power is turned off; ROM retains its information whether it has power or not.

Menu Bar A bar at the top of the GEM Desktop. When you first start up the ST Computer system, the headings on the Menu Bar are: Desk, File, View, and Options. Other application programs may have different headings.

MIDI Interface MIDI stands for Musical Instrument Digital Interface. It is a standard interface designed to connect a computer to a number of electronic musical devices.

Modem A device that allows you to connect your computer directly to the telephone lines and establish a communication link with other computers and online information networks.

Mouse The device that controls the movement of the mouse pointer on the desktop. As you slide the mouse across your table or desk, the small rubber ball on the bottom rolls back and forth to track the movements. The mouse has two buttons. The left button is used to select and open files, icons, and programs. The right button is used with some application programs.

Move Bar The bar at the top of an active window. Click on the Move Bar to drag a window to a new location on the desktop.

Parallel Interface An industry-standard interface for high-speed printer connections. On the back of the ST Computer, the parallel interface port is labeled "Printer."

Peripheral Any kind of exterior device that you connect to your computer (i.e., disk drive, monitor, printer).

Pixel The ST Computer video display is made up of tiny dots called "pixels" (picture elements). The pixels are arranged in a grid, and set to either 320 x 200, 640 x 200, or 640 x 400 dots per grid.

Pointer An arrow (also called the "mouse pointer") used to point to objects on the desktop. It follows your movement of the mouse (or cursor keys) forward, backward, left, or right.

Program File A file that contains an applications program. Program file icons are boxes shaded at the top.

RAM Random Access Memory. The part of the computer's memory that is used to "write to" and "read information from." When you work with your computer, the display on the screen is in RAM. The information stored in RAM is lost each time you turn off the computer.

RGB Red, Green, Blue. The color signals that the ST Computer produces to create its special color display. The combination of eight different intensities of red, green, and blue enable you to create 512 colors with the ST Computer.





ROM Read Only Memory. The part of the computer's memory containing the boot (startup) information for the computer. ROM is programmed at the factory and never changes.

RS232 The RS232 connector is an industry-standard connection for peripherals. On the back of the ST Computer, this connector is labeled "Modem." The RS232 port is also referred to as the serial port. Serial printers may also be connected to the ST Computer through this port.

Scroll To move the information in a window left, right, up, or down.

Scroll Bar One of two bars that border an active window on the bottom and right edges. The Scroll Bars contain the scroll arrows, and are shaded if part of the window's contents cannot be seen. The larger the shaded portion, the greater the percentage of the window's contents that is hidden from view.

Sector A section of a track on a hard or floppy disk. Sectors are usually 128, 256, 512, or 1024 bytes long. On an ST floppy disk, the sectors are 512 bytes long. (See **Track**.)

Size Box A small box at the lower right-hand corner used to change the size of the window.

Sizing The process of changing the size or shape of a window.

ST Language Disk The disk that came with your computer. It contains ST BASIC, a sample program, and the Desk Accessory files (the CONTROL.ACC and EMULATOR.ACC). You should make a copy of this disk immediately; label the copy "Working ST Language."

TOS The (ST) Operating System. TOS controls how the computer operates the GEM Desktop, the mouse, and any peripherals you connect to the computer.

Track One of the circular paths on a disk that contains the data written on the disk. Each track is made up of smaller sections called sectors. (See **Sector**.)

Trash The GEM Desktop icon used to delete files or folders from the desktop. Once a file or folder is deleted using the Trash icon, it's gone forever.

VT52 (Terminal) Emulator A communications program you can use to turn your ST Computer into a terminal linked to another computer (modem required).

Window The work area that the ST Computer uses to display files and folders or to run programs. The desktop allows up to four windows open at a time.

Working ST Language Disk A copy of your ST Language disk. Make this copy before you do anything else. Always use the copy when you need to access any information contained on the ST Language disk.



Write-Protect To mechanically prevent a disk from being written to. To write-protect a disk, move the write-protect tab so you can see through the write-protect notch, or so the tab is at the bottom position in the notch.



INDEX

A

Alert messages, 23, 70
Alternate key, 18, 22, 56, 71
Applications programs, 40, 68-70, 73-76
problems, 77

B

Back panel, 11
BASIC, 24, 41, 73-74
Baud rate, 59
Bee icon, 16
Bell icon, 57
Bits/Char, 59
Bytes
available, 62-63, 65
used, 35, 62-63

C

Calendar window, 56
Canceling
icons, 20
menu options, 22
Cartridge, 13
Clicking, 20
Clock window, 56
Close Box, 39, 56, 64
Close option, 64
Close Window option, 64
Closing
files, 39, 64
windows, 39, 64
Color selection, 57-58
Color selector, 60
Confirm Copies option, 70
Confirm Deletes option, 70
Connecting the system, 5-9
problems, 77
CONTROL.ACC file, 41, 42, 54, 71
copying, 41-42
Control key, 18, 56
Control Panel option, 55-58
Copying
disks, 27-28, 48
files, 41-44, 48
to folders, 50

Creating folders, 47, 50
Cursor, 46
Cursor keys, 17, 18, 22, 56

D

Data files, 40, 66, 68, 69
Database programs, 75
Deleting
files, 33, 46, 48
folders, 51
Desk Accessories, 42, 53, 54, 70, 78
Desk Menu, 53-61
Desk option, 53
Desktop disk, 41-42, 54, 70, 71
DESKTOP.INF, 71
Desktop Info option, 54
Dialog Box, 23
Directories, 50-51
Disk drive, 6, 9, 14, 29
Drive A, 9
Drive B, 9, 12
Drive C, 11
Drive c, 13
Hard Disk Drive, 11
ports, 11-14
Disk Identifier, 35
Disks, 29-31, 64-65
caring for, 79
destination, 28
double-sided, 29, 43, 48
problems, 77, 78
single-sided, 29, 43, 48
source, 28
Double-clicking, 34, 40-41, 56-57, 62
Dragging, 22
Duplex, 59

E

Educational programs, 76
EMULATOR.ACC file, 42, 54, 71
copying, 41-42
Entertainment programs, 75
Esc key, 18, 39, 42, 46, 56, 63



F

File Menu, 62–65
Filenames, 46, 51, 66, 69, 70
 changing, 46
Finger/Key icons, 56
Floppy Disk icon, 33
Folders, 47–51
Format option, 64–65
Formatting disks, 25–27, 64–65
Front panel, 6
Full Box, 37

G

GEM, 17, 69
GEM Desktop, 16, 17, 78

H

Help key, 55, 71
High-Resolution
 Monochrome Monitor, 7, 12, 57, 70
 port, 7, 12

I

Information Line, 35
Install Application option, 68–70
Install Disk Drive option, 68
Installing applications, 68–70
Install Printer option, 60–61

J

Joystick, 14
 port, 14

K

Keyboard, 17–18, 56, 78
Keys, 17–18
 cursor (arrow), 17–18, 22, 56
 function, 18
Keytop icon, 57

L

Left side panel, 13
LOGO, 74
Lo/Hi switch, 12

M

Mains lead, 10
 connecting a 3-pin plug, 10
Maintenance, preventive, 79–80
Menu Bar, 17, 53
MIDI, 13
 ports, 13
 software, 76
Modem, 11, 55, 58–60, 76
 port, 11, 55, 61
Mouse, 7, 14, 18–22
 caring for, 79
 port, 7, 14
 problems, 78
 using pointer, 18–22
Move Bar, 35, 36
Moving windows, 36
Multiple selections, 44–45

N

Naming disks, 65
NEOchrome, 75
New Folder option, 47, 63–64

O

On/Off switch, 12
Opening
 files, 40–41
 folders, 49–50
 windows, 34–35
Open option, 40, 49, 62
Options Menu, 67–71

P

Palette Control selector, 57–58
Paper Type selector, 61
Parity, 59
Pathnames, 50–51
Pixels/Line selector, 61
Printer, 11
 port, 11, 61
Printer Port selector, 61
Printer Type selector, 60
.PRG files, 70
Print Screen option, 60, 71
Program files, 40



Q

Quality selector, 61

R

Rabbit/Turtle icons, 56
Read-Only option, 63
Read/Write option, 63
Renaming files, 46, 63
Reset button, 12
Resolution
 screen, 58, 70
Resting Mouse/Running Mouse icons,
 56, 57
Reverse shading, 20, 21
RGB Analog Color Monitor, 7, 12, 57, 70
 port, 7, 12
Right side panel, 14
Right underside, 14
RS232 devices, 11, 58–60
 modem, 11, 58–60
 port, 11, 58, 59, 60, 61
Rt/Cts, 60
Running programs, 73

S

SAMPLE.PRG, 41
Save Desktop option, 71
Scroll Arrows, 35
Scroll Bars, 35, 38, 39
Scrolling windows, 38–39
Selecting
 icons, 20–21, 34, 44–45
 menu options, 21, 53
Select Screen Resolution option, 70
Set Preferences option, 70
Set RS232 Configuration option, 58–60
Show as Icons option, 66
Show as Text option, 66
Show Info option, 46, 62–63
Size Box, 37
Sizing windows, 37–38
Slow Boot/Fast Boot, 78
Sort by Date option, 66–67
Sort by Name option, 66–67
Sort by Size option, 66
Sort by Type option, 66
Spreadsheet programs, 75

ST Language disk, 24–28, 41, 42, 73, 74
 copying, 27–28

Strip Bit, 59

Switching on (booting) the system, 15–16
 problems, 16
 without the Desktop disk, 54

T

Telecommunications software, 76
Television, 7, 12, 57, 70
 jack, 8, 12
TOS, 69, 73
.TOS files, 70
TOS-takes parameters option, 69
Trash icon, 33, 46, 51
Troubleshooting, 77
.TTP files, 70

U

Undo key, 55
Updating windows, 39, 42

V

Video display, 7, 57, 58, 70
View Menu, 65–67
VT52 Emulator option, 55

W

Warm start, 12
Word processors, 74–75
Write-protecting disks, 30–31

X

Xon/Xoff, 60, 61





CUSTOMER SUPPORT

Atari Corporation welcomes questions about your ATARI Computer products. Write to:

Atari Corp (UK) Ltd.
Customer Relations
Atari House
Railway Terrace
Slough, Berkshire SL2 5BZ

Please write the subject of your letter on the outside of the envelope.

ATARI User Groups are outstanding sources of information on how to get the most from your ATARI Computer. To receive a list of ATARI User Groups in your area, send a self-addressed, stamped envelope to:

Atari Corp (UK) Ltd.
User Group List
Atari House
Railway Terrace
Slough, Berkshire SL2 5BZ





Copyright ©1987, Atari Corporation
Sunnyvale, CA 94089
All rights reserved.



C026406-002 REV. D.
C026406-0B3
K. I. 11. 1991

